

# Agilent 86037B Chromatic Dispersion Test System User's Guide

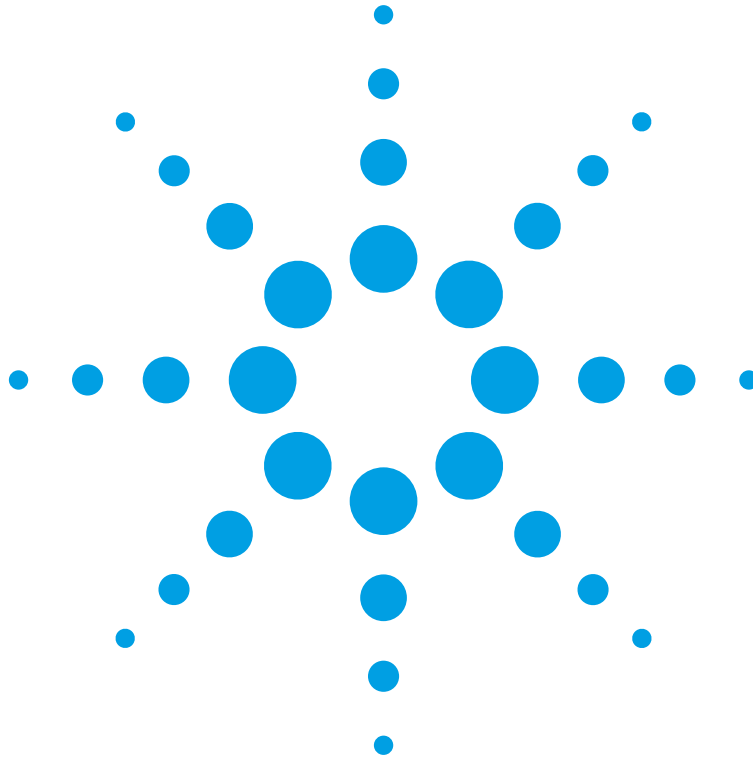

**Agilent Technologies**

© Copyright  
Agilent Technologies 2000  
All Rights Reserved. Reproduction, adaptation, or translation without prior written permission is prohibited, except as allowed under copyright laws.

Agilent Part No. 86037-90024  
Printed in USA  
March 2000

Agilent Technologies  
Lightwave Division  
1400 Fountaingrove Parkway  
Santa Rosa, CA 95403-1799,  
USA  
(707) 577-1400

### Notice.

The information contained in this document is subject to change without notice. Companies, names, and data used in examples herein are fictitious unless otherwise noted. Agilent Technologies makes no warranty of any kind with regard to this material, including but not limited to, the implied warranties of merchantability and fitness for a particular purpose. Agilent Technologies shall not be liable for errors contained herein or for incidental or consequential damages in connection with the furnishing, performance, or use of this material.

### Restricted Rights Legend.

Use, duplication, or disclosure by the U.S. Government is subject to restrictions as set forth in subparagraph (c) (1) (ii) of the Rights in Technical Data and Computer Software clause at DFARS 252.227-7013 for DOD agencies, and subparagraphs (c) (1) and (c) (2) of the Commercial Computer Software Restricted Rights clause at FAR 52.227-19 for other agencies.

### Warranty.

This Agilent Technologies instrument product is warranted against defects in

material and workmanship for a period of one year from date of shipment. During the warranty period, Agilent Technologies will, at its option, either repair or replace products which prove to be defective. For warranty service or repair, this product must be returned to a service facility designated by Agilent Technologies. Buyer shall prepay shipping charges to Agilent Technologies and Agilent Technologies shall pay shipping charges to return the product to Buyer. However, Buyer shall pay all shipping charges, duties, and taxes for products returned to Agilent Technologies from another country.

Agilent Technologies warrants that its software and firmware designated by Agilent Technologies for use with an instrument will execute its programming instructions when properly installed on that instrument. Agilent Technologies does not warrant that the operation of the instrument, or software, or firmware will be uninterrupted or error-free.

### Limitation of Warranty.

The foregoing warranty shall not apply to defects resulting from improper or inadequate maintenance by Buyer, Buyer-supplied software or interfacing, unauthorized modification or misuse, operation outside of the environmental specifications for the product, or improper site preparation or maintenance.

No other warranty is expressed or implied. Agilent Technologies specifically disclaims the implied warranties of merchantability and fitness for a particular purpose.

### Exclusive Remedies.

The remedies provided herein are buyer's sole and exclusive remedies. Agilent Technolo-

gies shall not be liable for any direct, indirect, special, incidental, or consequential damages, whether based on contract, tort, or any other legal theory.

### Safety Symbols.

#### CAUTION

The *caution* sign denotes a hazard. It calls attention to a procedure which, if not correctly performed or adhered to, could result in damage to or destruction of the product. Do not proceed beyond a caution sign until the indicated conditions are fully understood and met.

#### WARNING

The *warning* sign denotes a hazard. It calls attention to a procedure which, if not correctly performed or adhered to, could result in injury or loss of life. Do not proceed beyond a warning sign until the indicated conditions are fully understood and met.



The instruction manual symbol. The product is marked with this warning symbol when it is necessary for the user to refer to the instructions in the manual.



The laser radiation symbol. This warning symbol is marked on products which have a laser output.



The AC symbol is used to indicate the required nature of the line module input power.



The ON symbols are used to mark the positions of the instrument power line switch.



The OFF symbols are used to mark the positions of the instrument power line switch.



The CE mark is a registered trademark of the European Community.



The CSA mark is a registered trademark of the Canadian Standards Association.



The C-Tick mark is a registered trademark of the Australian Spectrum Management Agency.

ISM1-A

This text denotes the instrument is an Industrial Scientific and Medical Group 1 Class A product.

### Typographical Conventions.

The following conventions are used in this book:

Key type for keys or text located on the keyboard or instrument.

*Softkey type* for key names that are displayed on the instrument's screen.

Display type for words or characters displayed on the computer's screen or instrument's display.

**User type** for words or characters that you type or enter.

*Emphasis type* for words or characters that emphasize some point or that are used as place holders for text that you type.

---

## Software License

The following License Terms govern your use of the accompanying Software unless you have a separate signed agreement with Agilent Technologies.

**License Grant.** Agilent grants you a license to Use one copy of the Software. “Use” means storing, loading, installing, executing or displaying the Software. You may not modify the Software or disable any licensing or control features of the Software. If the Software is licensed for “concurrent use,” you may not allow more than the maximum number of authorized users to Use the Software concurrently.

**Ownership.** The Software is owned and copyrighted by Agilent or its third party suppliers. Your license confers no title to, or ownership in, the Software and is not a sale of any rights in the Software. Agilent’s third party suppliers may protect their rights in the event of any violation of these License Terms.

**Copies and Adaptations.** You may only make copies or adaptations of the Software for archival purposes or when copying or adaptation is an essential step in the authorized Use of the Software. You must reproduce all copyright notices in the original Software on all copies or adaptations. You may not copy the Software onto any public network.

**No Disassembly or Decryption.** You may not disassemble or decompile the Software unless Agilent’s prior written consent is obtained. In some jurisdictions, Agilent’s consent may not be required for lim-

ited disassembly or decompilation. Upon request, you will provide Agilent with reasonably detailed information regarding any disassembly or decompilation. You may not decrypt the Software unless decryption is a necessary part of the operation of the Software.

**Transfer.** Your license will automatically terminate upon any transfer of the Software. Upon transfer, you must deliver the Software, including any copies and related documentation, to the transferee. The transferee must accept these License Terms as a condition of the transfer.

**Termination.** Agilent may terminate your license upon notice for failure to comply with any of these License Terms. Upon termination, you must immediately destroy the Software, together with all copies, adaptations and merged portions in any form.

**Export Requirements.** You may not export or re-export the Software or any copies or adaptation in violation of any applicable laws or regulations.

**U.S. Government Restricted Rights.** The Software and Documentation have been developed entirely at private expense. They are delivered and licensed as “commercial computer software” as defined in DFARS 252.227-7013 (Oct 1988), DFARS 252.211-7015 (May 1991) or DFARS 252.227-7014 (Jun 1995), as a “commercial item” as defined in FAR 2.101(a), or as “Restricted computer software” as defined in FAR 52.227-19 (Jun 1987) (or any equivalent agency regulation or contract clause), whichever

is applicable. You have those rights provided for such Software and Documentation by the applicable FAR or DFARS clause or the Agilent standard software agreement for the product involved.

**Limited Software Warranty.** Agilent Technologies warrants for a period of one year from the date of purchase that the software product will execute its programming instructions when properly installed on the instrument indicated on this package. Agilent Technologies does not warrant that the operation of the software will be uninterrupted or error free. In the event that this software product fails to execute its programming instructions during the warranty period, Customer’s remedy shall be to return the media to Agilent Technologies for replacement. Should Agilent Technologies be unable to replace the media within a reasonable amount of time, Customer’s alternate remedy shall be a refund of the purchase price upon return of the product and all copies.

**Media.** Agilent Technologies warrants the media upon which this product is recorded to be free from defects in materials and workmanship under normal use for a period of one year from the date of purchase. In the event any media prove to be defective during the warranty period, Customer’s remedy shall be to return the media to Agilent Technologies for replacement. Should Agilent Technologies be unable to replace the media within a reasonable amount of time, Customer’s alternate remedy shall be a

refund of the purchase price upon return of the product and all copies.

**Notice of Warranty Claims.** Customer must notify Agilent Technologies in writing of any warranty claim not later than thirty (30) days after the expiration of the warranty period.

**Limitation of Warranty.** Agilent Technologies makes no other express warranty, whether written or oral, with respect to this product. Any implied warranty of merchantability or fitness is limited to the one year duration of this written warranty.

This warranty gives specific legal rights, and Customer may also have other rights which vary from state to state, or province to province.

**Exclusive Remedies.** The remedies provided above are Customer’s sole and exclusive remedies. In no event shall Agilent Technologies be liable for any direct, indirect, special, incidental, or consequential damages (including lost profit) whether based on warranty, contract, tort, or any other legal theory.

**Warranty Service.** Warranty service may be obtained from the nearest Agilent Technologies sales office or other location indicated in the owner’s manual or service booklet.

## General Safety Considerations

This product has been designed and tested in accordance with IEC Publication 61010-1, Safety Requirements for Electrical Equipment for Measurement, Control and Laboratory Use, and has been supplied in a safe condition. The instruction documentation contains information and warnings that must be followed by the user to ensure safe operation and to maintain the product in a safe condition.

---

**WARNING**

---

**If this instrument is not used as specified, the protection provided by the equipment could be impaired. This instrument must be used in a normal condition (in which all means for protection are intact) only.**

---

**WARNING**

---

**To prevent electrical shock, disconnect the Agilent 86037B from mains before cleaning. Use a dry cloth or one slightly dampened with water to clean the external case parts. Do not attempt to clean internally.**

---

**WARNING**

---

**This is a Safety Class 1 product (provided with a protective earthing ground incorporated in the power cord). The mains plug shall only be inserted in a socket outlet provided with a protective earth contact. Any interruption of the protective conductor inside or outside of the product is likely to make the product dangerous. Intentional interruption is prohibited.**

---

**WARNING**

---

**No operator serviceable parts inside. Refer servicing to qualified personnel. To prevent electrical shock, do not remove covers.**

---

**WARNING**

---

**For continued protection against fire hazard, replace line fuse only with same type and ratings, (type T 0.315A/250V for 100/120V operation and 0.16A/250V for 220/240V operation). The use of other fuses or materials is prohibited. Verify that the value of the line-voltage fuse is correct.**

- For 100/120V operation, use an IEC 127 5×20 mm, 0.315 A, 250 V, Agilent part number 2110-0449.
- For 220/240V operation, use an IEC 127 5×20 mm, 0.16 A, 250 V, Agilent Technologies part number 2110-0448.

---

**CAUTION**

Before switching on this instrument, make sure that the line voltage selector switch is set to the line voltage of the power supply and the correct fuse is installed. Assure the supply voltage is in the specified range.

---

**CAUTION**

This product is designed for use in Installation Category II and Pollution Degree 2 per IEC 1010 and 664 respectively.

---

**CAUTION**

**VENTILATION REQUIREMENTS:** When installing the product in a cabinet, the convection into and out of the product must not be restricted. The ambient temperature (outside the cabinet) must be less than the maximum operating temperature of the product by 4°C for every 100 watts dissipated in the cabinet. If the total power dissipated in the cabinet is greater than 800 watts, then forced convection must be used.

---

**CAUTION**

Always use the three-prong ac power cord supplied with this instrument. Failure to ensure adequate earth grounding by not using this cord may cause instrument damage.

---

**CAUTION**

*Do not* connect ac power until you have verified the line voltage is correct. Damage to the equipment could result.

---

**CAUTION**

This instrument has autoranging line voltage input. Be sure the supply voltage is within the specified range.

---



---

# Contents

General Safety Considerations iv

## **1 Quick Start**

A Quick Tour 1-6

Measuring Fiber Devices 1-10

Measuring Grating Devices 1-13

## **2 Operation**

The Main Window 2-3

The Review Data Window 2-23

Using Database Files 2-32

Checking Test Fiber Stability 2-35

## **3 Normalization**

Normalizing the Test Setup 3-4

Verifying a Test Setup Normalization 3-6

Adjusting the Modulator Bias 3-7

Normalizing the Laser 3-8

Adjusting the Power Monitor 3-10

Setting Normalization Preferences 3-13

## **4 Remote Control**

Setting up a Measurement 4-4

Performing a Measurement 4-13

Reading the Measurement Results 4-16

TES Parameters 4-21

TES Min/Max Parameters 4-38

Output Parameters 4-41

## **5 Maintenance**

Troubleshooting Common Problems 5-3

Verification Tests 5-9

Reinstalling the System Software 5-16

Agilent Technologies Support and Maintenance 5-18

Cleaning Connections for Accurate Measurements 5-20

Electrostatic Discharge Information 5-30

Returning the Instrument for Service 5-32

## **Contents**

Agilent Technologies Service Offices 5-35

### **6 Installation**

### **7 Reference**

Theory of Operation 7-2

Rack Diagram 7-6

Chromatic Dispersion—theory and management 7-8

Measurement Repeatability 7-11

Material Lists 7-13

Power Cords 7-16

System Options 7-17

### **8 Specifications and Regulatory Information**

Specifications 8-3

Regulatory Information 8-7



---

# 1

|                           |      |
|---------------------------|------|
| Operation—At a Glance     | 1-2  |
| A Quick Tour              | 1-6  |
| Measuring Fiber Devices   | 1-10 |
| Measuring Grating Devices | 1-13 |

---

## Quick Start

## Operation—At a Glance

The Agilent 86037B is a complete solution for measuring chromatic dispersion in fiber-optic cables, dispersion compensating devices, gratings, and other components. The system performs near-end measurements where there is access to both ends of a test device at the same location.

Your Agilent 86037B should have already been installed by an Agilent Technologies engineer. If in the future, you should need to review the installation procedures, refer to Chapter 6, “Installation”.

### ***Learn about your system***

- To learn how to make measurements, read “A Quick Tour” on page 1-6.
- If your measuring grating based devices, read “Measuring Grating Devices” on page 1-13.
- To learn about chromatic dispersion theory, refer to “Chromatic Dispersion—theory and management” on page 7-8. Also, refer to *Fiber Optic Test and Measurement* a Hewlett-Packard<sup>1</sup> Professional Book available from Prentice Hall (ISBN 0-13-534330-5).
- To learn about available support options, refer to “Agilent Technologies Support and Maintenance” on page 5-18.
- The Agilent 86037B system uses the Windows NT<sup>®2</sup> operating system. To learn about Windows NT, refer to your Microsoft<sup>®3</sup> Windows NT User’s Guide.

1. Hewlett-Packard and HP are U.S. registered trademarks of Hewlett-Packard Company.

2. Windows NT<sup>®</sup> is a U.S. registered trademark of Microsoft Corporation.

3. Microsoft<sup>®</sup> is a U.S. registered trademark of Microsoft Corporation.

***Single band versus dual band systems***

This chapter describes how to operate both the single band and dual band versions of the Agilent 86037B. With a few minor exceptions, their operation is identical. Some of the figures in this chapter show features only found on the dual band systems. If you're using a single band system, simply ignore the features which are not found on your system.

**Operation—At a Glance**

---

**WARNING**

**Agilent 86037B and Agilent 83427A: If the system or test set products are not used as specified, the protection provided by the equipment could be impaired. These products must be used in a normal condition (in which all means for protection are intact) only.**

---

**WARNING**

**To prevent accidental exposure to laser light, always verify the ACTIVE indicator is off on the tunable laser source before removing or connecting fiber-optic cables, adapters, or devices under test. Never remove or connect fiber-optic cables, adapters, or devices while a measurement is in progress.**

---

**WARNING**

**During measurements, laser light emits from the front-panel SOURCE OUTPUT connector. This light originates from the system's tunable laser source. Always keep the SOURCE OUTPUT connector covered when not in use.**

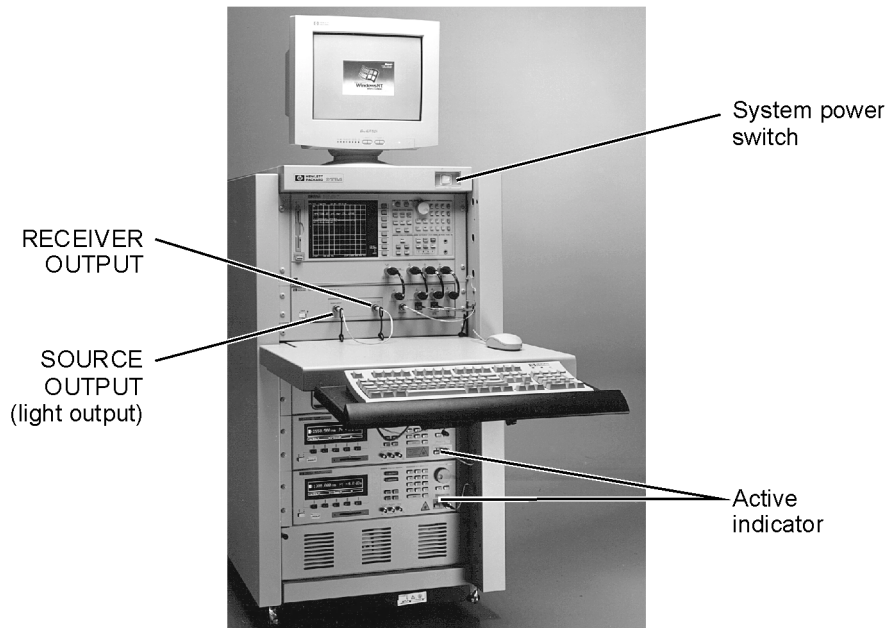

---

**CAUTION**

The warranty and calibration will be voided on systems where the individual instruments, including fiber-optic cables, RF cables, or GPIB cables are removed by the customer. The system should only be disassembled by a Agilent Technologies Customer Engineer. Instruments should not be swapped or removed by non-Agilent Technologies personnel.

**Measurement accuracy—it's up to you!**

Fiber-optic connectors are easily damaged when connected to dirty or damaged cables and accessories. The Agilent 86037B's front-panel SOURCE OUTPUT and RECEIVER INPUT connectors are no exception. When you use improper cleaning and handling techniques, you risk expensive instrument repairs, damaged cables, and compromised measurements. Before you connect any fiber-optic cable to the Agilent 86037B, refer to "Cleaning Connections for Accurate Measurements" on page 5-20.

---

## A Quick Tour

This procedure steps you through the process of making your first chromatic dispersion measurement. Because the system defaults to measuring fiber-based devices (versus grating-based devices) use a fiber-based device for testing in this procedure. It should take approximately 20 minutes to complete.

- 1 Press the system power switch to turn on the system.

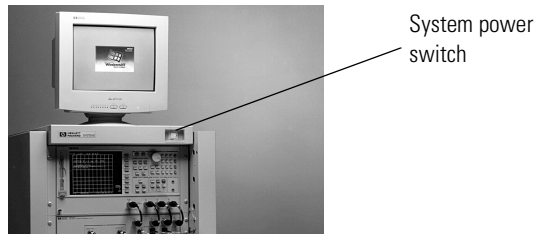

- 2 When the Windows desktop appears, click on the HP CD icon.
- 3 The two procedures listed below should have been performed as part of the system installation procedure. If they have not yet been performed, perform them at this time.
  - “Normalizing the Laser” on page 3-8.
  - “Adjusting the Power Monitor” on page 3-10.
- 4 On the Service menu, click Select TLS. Click the appropriate button to enable the tunable laser source. For safety reasons, the default value is OFF.

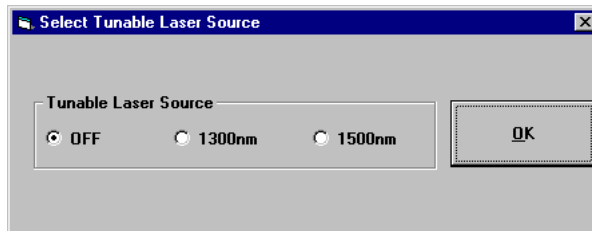

- 5 Enter the test identification information for your test. See the “Test identification area” in [Figure 1-1 on page 1-7](#). This includes items such as the type of fiber, a descriptive name, the manager and operator’s names.

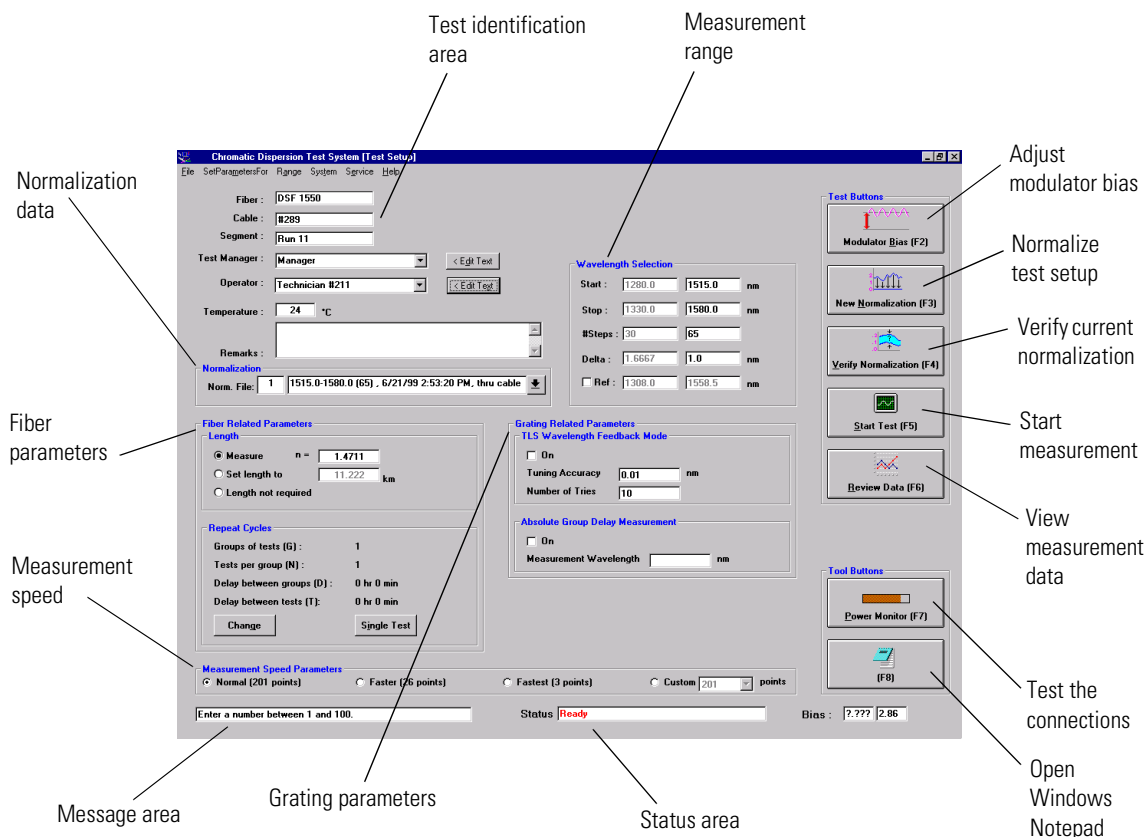

**Figure 1-1. Application features**

- 6 In the “Measurement range” area, enter the start, stop, and step wavelengths.
- 7 On the SetParametersFor menu, click CD/  
Gain Meas. In the dialog box, click Set HP  
Defaults and then OK.
- 8 On the SetParametersFor menu, click Length  
Meas. In the dialog box, click Set HP Defaults and then OK.
- 9 On the File menu, click Save Setup As to  
save all of the settings made so far into a  
setup file.

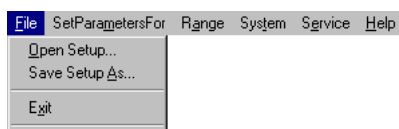
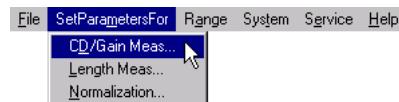

## A Quick Tour

The title bar displays the name of the setup file that is currently open. You can recall this file at any time to automatically configure the system to your specific measurement settings. You can create as many setup files as you may need.

### ***Normalizing the test setup***

The system must warm up for two hours before test setup normalizations and measurements can be made. While your system is warming up, spend some time familiarizing yourself with the remaining information in this chapter.

- 10 Connect the device being tested to the system.

Use patch cords to connect the SOURCE OUTPUT and RECEIVER INPUT connectors to the device you are testing. This step determines the cables required in order to protect the system's fiber-optic connectors from wear.

- 11 Remove the device being tested from the test setup and *replace the device with a patch cord*. Retain as many of the test setup cables as possible.



- 12 Click Power Monitor, and confirm that the power levels indicate that good low-loss connections have been made.

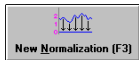

- 13 Click New Normalization to normalize the measurement setup. Then, click *Start Normalization*.

Chapter 3, "Normalization" describes the various normalization procedures and adjustments available for your system.

- 14 After the normalization has completed, click Close.

### ***Performing a measurement***

- 15 Remove the patch cord inserted in [Step 11](#) and reinsert the device being tested. Be sure to use the same cables that you used in [Step 10](#).

- 16 Click Power Monitor, and confirm that the power levels indicate that good low-loss connections have been made.

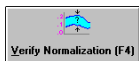

- 17 Click Verify Normalization.

Use this step to confirm that the normalization is still valid.



- 18 Click Start Test to begin a CD measurement.



Messages in the status line (located at the bottom of the display) show the test's progress. After a few seconds, the Data Monitor window appears. While the test is in progress, you can toggle the views between displayed graph and list panes.

- After the test has completed, the Data Review window is automatically displayed. Refer to “The Review Data Window” on page 2-23 to learn about the available options for viewing your data.
- Measurement results can be saved for future review. Refer to “Using Database Files” on page 2-32 to learn about this capability.

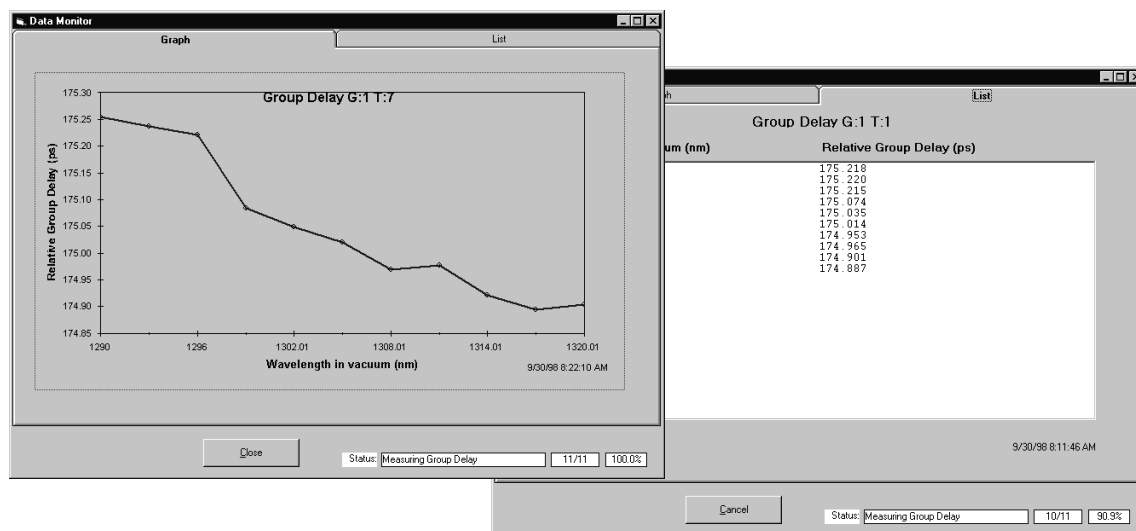

**Figure 1-2. Measurement progress shown in the Graph and List panes**

### ***Turning the system off***

#### **CAUTION**

Turning the system off *without* performing the following steps may damage the application files.

- 19** On the File menu, click Exit, and move the mouse pointer to the bottom of the display to show the Windows NT taskbar.
- 20** Click on Start and then Shut Down.
- 21** When the computer screen indicates that the computer can be turned off, press the system's power switch.

---

## Measuring Fiber Devices

In this section, you'll learn how to optimize measurements on fiber devices. You can, of course, skip this section and immediately begin making measurements on your devices. However, be sure to read this material later to increase your understanding of chromatic dispersion measurements.

By adjusting the RF modulation frequency, you can optimize measurement accuracy. (Refer to the sidebar, "Assumptions required for this optimization method" on page 1-12.) For information on changing the modulation frequency, refer to "CD/Gain Meas command" on page 2-15.

Because the system's accuracy varies as a function of RF modulation frequency, for optimum accuracy keep the modulation frequency above 1 GHz and preferably at 2 GHz. This puts some restrictions on the wavelength step size because too large of a step size results in a phase "wrap-around" where the phase jump exceeds 360° as the wavelength is stepped. Use the following formula to determine the maximum step size:

$$(\Delta\lambda)_{MAX} = \frac{500}{S_0 f_m \lambda_{SPAN} L}$$

where:

$(\Delta\lambda)_{MAX}$  is the maximum allowed step size (in nm) to keep the modulation frequency at the desired value  $f_m$ .

$f_m$  is the desired modulation frequency (in GHz).

$S_0$  is the dispersion slope in ps/(nm<sup>2</sup>×km).

$\lambda_{SPAN}$  is the spectral span (stop  $\lambda$  – start  $\lambda$ ) of the measurement in nm.

$L$  is the length of the system/fiber in km.

Suppose, for example, that you wanted to measure chromatic dispersion on a 70 km spool of dispersion shifted fiber between 1515 nm and 1575 nm. Select the optimum modulation frequency of 2 GHz, and use the above equation to determine the maximum allowed wavelength step size. Assuming the fiber's dispersion slope is 0.07 ps/(nm<sup>2</sup> km), then:

$f_m$  is 2 GHz.

$S_0$  is 0.07 ps/(nm<sup>2</sup>×km).

$\lambda_{SPAN}$  is 60 nm.

L is 70 km.

Substituting these values into the above equation, we have:

$$(\Delta\lambda)_{MAX} = \frac{500}{\frac{0.07 \text{ ps}}{\text{nm}^2 \text{ KM}} \times 2 \text{ GHz} \times 60 \text{ nm} \times 70 \text{ km}}$$

Note that 0.85 nm is the maximum allowed step size. Steps shorter than 0.85 nm are permitted. The 0.85 nm step size results in about 70 steps for the measurement.

You can reduce the measurement time using the following techniques:

- Sacrifice accuracy for measurement speed by choosing a lower modulation frequency.

For the example above, if we make  $f_m$  equal to 1 GHz, the step size can be increased to 1.7 nm. This results in about 35 steps for the measurement and thereby halving the measurement time.

- Make a survey measurement with a wide wavelength range and a lower modulation frequency, for example, 500 MHz. Then, raise the modulation frequency, for example, to 2 GHz, but narrow down  $\lambda_{SPAN}$  by zooming into the wavelength range of interest.

In the above equation, a reduction of  $\lambda_{SPAN}$  by a factor of 2 will increase the maximum allowed step size  $(\Delta\lambda)_{MAX}$  by 2. The number of steps,  $\propto \lambda_{SPAN} / (\Delta\lambda)_{MAX}$ , and therefore the measurement time, will decrease by a factor of 4.

In this example, reducing the measurement span from 60 to 30 nm increases the maximum allowed step size from 0.85 nm to 1.7 nm. The measurement time decreases from about 9 minutes to about 2 minutes and 15 seconds.

**Assumptions required for this optimization method**

**Assumption 1.** The group delay can be modeled by the quadratic equation:

$$\tau_g(\lambda) = \frac{S_0}{2} (\lambda - \lambda_0)^2 L$$

Where  $S_0$  is the dispersion slope,  $\lambda$  is the wavelength,  $\lambda_0$  is the zero dispersion wavelength, and  $L$  is the fiber length. The precise details of the quadratic fit to the data are not critical; the only requirement is that the group delay curve should have the shape of a parabolic curve. In fact, the results presented here are valid even if the three-term or the five-term Sellmeier fits are used, as those two models also have the parabolic shape. This assumption is valid for systems consisting mostly of dispersion-shifted fiber.

**Assumption 2.** The dispersion slope  $S_0$  [in ps/(nm<sup>2</sup>×km)] is known. For example, the dispersion slope,  $S_0$ , is approximately 0.07 ps/(nm<sup>2</sup>×km) for most dispersion shifted fiber. The zero dispersion wavelength  $\lambda_0$  need not be known but should lie within the spectral range of the measurement.

---

## Measuring Grating Devices

In this section, you'll learn how to make measurements on grating based devices such as Bragg fiber gratings. It is recommended that you do not skip this section. Since the Agilent 86037B, by default, is set for making measurements on fiber devices, before measuring grating devices, perform the following steps:

- 1 Select Absolute Group Delay Measurement in the Grating Related Parameters area in the main window. (By default, relative group delay is measured.) Refer to “Absolute Group Delay Measurement” on page 2-14.



In addition to selecting absolute group delay, this selection turns off the review data window's curve fit selection. Although, curve fitting is a standard method used to reduce the effects of noise when measuring fiber based devices, there is currently no standard for grating based devices. You can, of course, export the data and apply your own corrections.

- 2 Set the Test Modulation Frequency to the Manual setting. Refer to “CD/Gain Meas command” on page 2-15 to configure this setting.

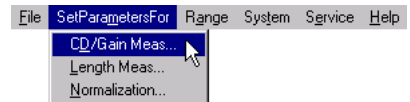

For details on determining the proper RF test modulation frequency, refer to “Setting the RF modulation frequency” on page 1-14.

- 3 Use larger wavelength steps during test setup normalization compared to during the measurement. This reduces overall test time.

Since patch cords used during normalization have very low dispersion, the system is able to interpolate accurate values for use with grating measurements. For example, if you are measuring a grating with 5 nm wavelength range, you could use 1 nm steps during normalization and 1 pm steps during measurements.

- 4 Expect large jumps in measured dispersion.

**Measuring Grating Devices**

Without the benefit of curve fitting and since dispersion is the derivative of the group delay, the effect of any noise is exaggerated. For example, large amounts of noise will be measured at wavelengths in a filter's cutoff region.

- 5 Use a 2 GHz RF modulation frequency with a small wavelength step size. Step sizes down to 1 pm are possible. To set the step size, refer to "Wavelength Selection area" on page 2-6.

**Setting the RF modulation frequency**

When selecting the RF modulation frequency, you'll want to select the highest frequency possible without introducing 360° phase shifts. This requires that you know the approximate group delay variation (between measurement wavelength steps) expected on the device that you are measuring.

Set the RF modulation frequency to a value which has a period that is at least twice the anticipated group delay between wavelength steps.

$$RF \text{ modulation frequency} \leq \frac{1}{2(\text{group delay between wavelength steps})}$$

For example, when measuring a grating device that has a variation in group delay of as much as 500 ps between wavelength steps, set the RF modulation frequency to 1 GHz or less. If you specify a wavelength step size of 2 pm to 100 pm, it is unlikely that any but the fastest gratings (such as tuning filters or dispersion compensation gratings) would require less than the default 2 GHz frequency.

|                                   |      |
|-----------------------------------|------|
| The Main Window                   | 2-3  |
| Test and Tool buttons             | 2-5  |
| Wavelength Selection area         | 2-6  |
| Test Identification area          | 2-8  |
| Normalization area                | 2-9  |
| Measurement Speed Parameters area | 2-10 |
| Fiber Related Parameters area     | 2-12 |
| Grating Related Parameters area   | 2-14 |
| File menu                         | 2-15 |
| SetParametersFor menu             | 2-15 |
| Range menu                        | 2-18 |
| System menu                       | 2-19 |
| Service menu                      | 2-22 |
| The Review Data Window            | 2-23 |
| Measurement review tabs           | 2-25 |
| File menu                         | 2-29 |
| Edit menu                         | 2-31 |
| Preferences menu                  | 2-31 |
| Using Database Files              | 2-32 |
| Checking Test Fiber Stability     | 2-35 |

## Operation—At a Glance

In this chapter, you'll find descriptions of the chromatic dispersion application's two window views along with their menu selections. The two window views (main and data review) are each described in a separate section. Additional sections describe database files and test fiber stability.

The chromatic dispersion application starts up in the main window from which you perform all measurements. After performing a measurement, the application automatically switches to the data review window.



## The Main Window

This section describes the settings and features located in the main window. You'll make all of your measurements from the main window. After performing your measurement, you can switch between the main and data review windows with the click of a button. Some settings can be made directly on the main window. Others are accessed through menu selections.

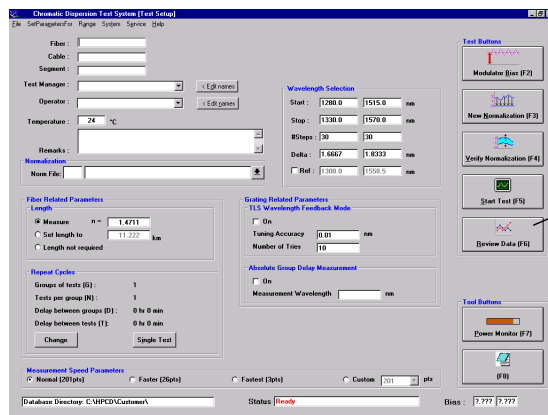

Click to display  
Review Data  
window

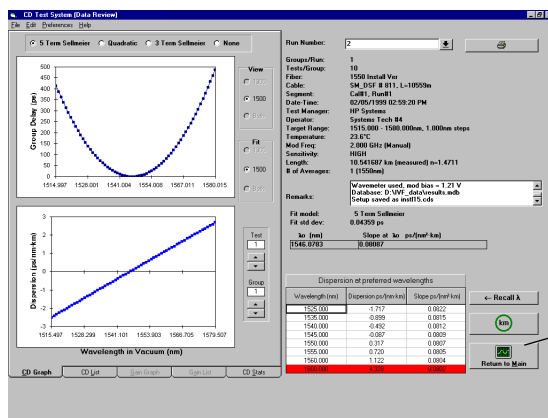

Click to return to  
Main window

Figure 2-1. Switching between main and data review windows





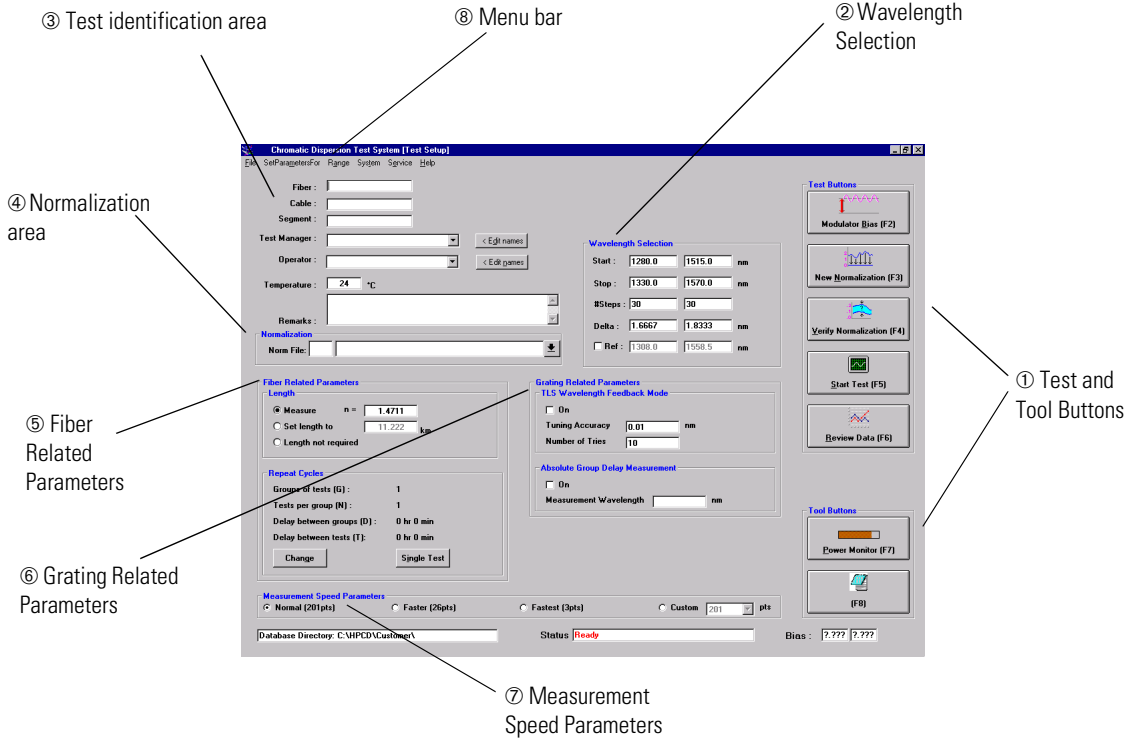

Operation  
**The Main Window**

**Where to find information on....**

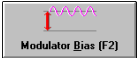
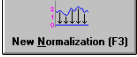

| Main Window | Refer to....  |
|-------------|---|
| ①           | "Test and Tool buttons" on page 2-5   |
| ②           | "Wavelength Selection area" on page 2-6   |
| ③           | "Test Identification area" on page 2-8  |
| ④           | "Normalization area" on page 2-9  |
| ⑤           | "Fiber Related Parameters area" on page 2-12 and "Measuring Fiber Devices" on page 1-10     |
| ⑥           | "Grating Related Parameters area" on page 2-14 and "Measuring Grating Devices" on page 1-13 |
| ⑦           | "Measurement Speed Parameters area" on page 2-10  |
| ⑧           | "File menu" on page 2-15 through "Service menu" on page 2-22                                |

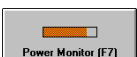
## Test and Tool buttons

| Button  | Description   |
|---|---|
|    | <p>Click to bias the modulator. To learn about biasing the modulator and normalizing your measurements, refer to Chapter 3, "Normalization".</p>  |
|    | <p>Click to remove any systematic effects of the test setup from the measurements. Refer to Chapter 3, "Normalization" for complete instructions.</p>   |
|    | <p>Click to verify that the current measurement normalization is accurate.</p>  |
|    | <p>Click to start a chromatic dispersion test.</p>  |
|    | <p>Click to display the Review Data window from which you can display, print, save, and recall your measurement data. Refer to "The Review Data Window" on page 2-23 for more information.</p>  |
|    | <p>Click to test signal levels through the device being tested and the test setup. Significant loss can be caused by damaged or improperly cleaned cables; refer to "Cleaning Connections for Accurate Measurements" on page 5-20. On dual band systems, click on either the low band (1300 nm) or high band (1500 nm) option buttons to select the TLS to be measured.</p> |
|  | <p>Click to start the Windows Notepad application from which you can write text files to document your measurement processes.</p>   |

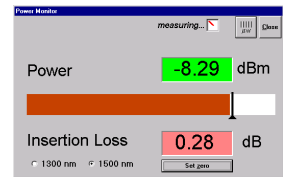

---

## Wavelength Selection area

The Wavelength Selection area shows the current wavelength settings. Single-band systems only show the settings for the single band. With dual-band systems, only the settings for the selected band are active. For example, this figure shows the 1500 nm band active. To activate a band, refer to “Range menu” on page 2-18 and turn on the appropriate band.

| Wavelength Selection           |        |        |    |
|--------------------------------|--------|--------|----|
| Start :                        | 1280.0 | 1515.0 | nm |
| Stop :                         | 1330.0 | 1570.0 | nm |
| #Steps :                       | 30     | 30     |    |
| Delta :                        | 1.6667 | 1.8333 | nm |
| <input type="checkbox"/> Ref : | 1308.0 | 1558.5 | nm |

### ***Start and Stop***

The start and stop wavelength settings define the limits of the test. The tunable laser source’s display shows an error message if the values in the start and stop wavelength fields are greater than the range of the tunable laser source. The Agilent 86037B application does not indicate an error. The shaded area in [Figure 2-2](#) shows the wavelength range where the selected tunable laser source power is more than the tunable laser source can deliver. If you select a wavelength range within the shaded area, the tunable laser source displays an error and continue to put out as much power as it can.

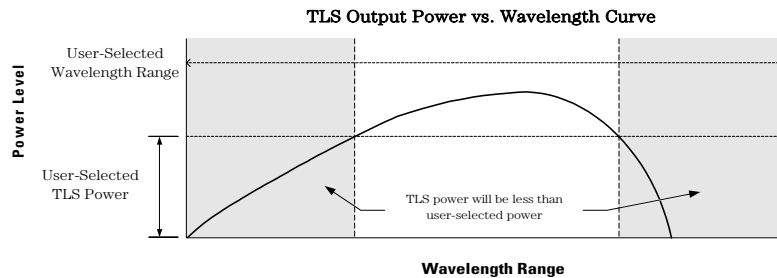

**Figure 2-2. TLS power roll-off in relation to wavelength range**

### ***# Steps and Delta***

The # Steps field sets the number of measurement points between the start and stop wavelengths. The Delta field shows the step size in nanometers between each measurement point. After entering values for one of these fields, the system automatically calculates the other field. The greater the number of data

points, or steps, the greater the measurement accuracy. However, as the number of steps increases, so does the measurement time. It is important to select enough steps to provide the required accuracy, but still allow for a timely measurement. When measuring fiber, using 20 steps yields good results. The following table shows typical measurement times for 20 steps using three different sensitivity settings. Refer to “Sensitivity” on page 2-16 for information on the sensitivity settings.

**Table 2-1. Example Measurement Times for 20 Measurement Steps**

| <b>Sensitivity</b> | <b>Measurement Time</b> |
|--------------------|-------------------------|
| Normal             | 2 minutes, 50 seconds   |
| High               | 4 minutes, 30 seconds   |
| Highest            | 10 minutes, 5 seconds   |

***Ref***

The Ref check box establishes a reference wavelength. The reference wavelength is used to correct length drifts of the device under test during the measurement and should be set when measuring fibers. It improves the accuracy of the measurement, but increases measurement time.

---

## Test Identification area

Use the test identification area to identify the device being measured along with the operator who runs the test. This information is stored with the test measurement results. You can also change the labels that are used to identify each field. For example, you could change the “Fiber” label to read “Multiplexer”. To learn how to change the labels, refer to “Record Labels command” on page 2-20.

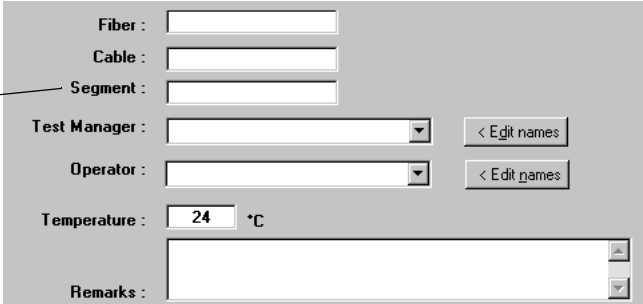

A screenshot of the Test Identification area form. The form contains several input fields and buttons. The fields are: Fiber (text box), Cable (text box), Segment (text box), Test Manager (drop-down menu), Operator (drop-down menu), Temperature (text box with a unit selector set to °C), and Remarks (text area). There are two buttons labeled "< Edit names" next to the Test Manager and Operator fields. A label "Labels" with a pointer line is positioned to the left of the Segment field.

After entering names into the Test Manager and Operator fields, these names can then be selected from the drop-down list box rather than typed. For example, identification numbers for different technicians can be entered in the Operator field as shown in the following figure.

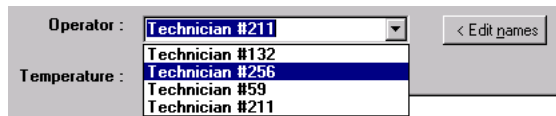

A screenshot of the Operator field in the Test Identification area. The Operator field is a drop-down menu showing a list of technicians: Technician #211, Technician #132, Technician #256, Technician #59, and Technician #211. The field is currently set to Technician #211. There is an "< Edit names" button to the right of the field.

Click on Edit names to display a dialog box from which you can add, change, or delete names from the list box.

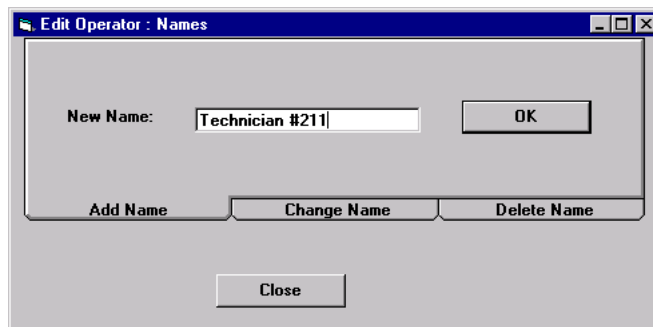

A screenshot of the "Edit Operator: Names" dialog box. The dialog box has a title bar with the text "Edit Operator: Names". Inside the dialog box, there is a "New Name:" label followed by a text box containing "Technician #211" and an "OK" button. Below this, there are three buttons: "Add Name", "Change Name", and "Delete Name". At the bottom of the dialog box, there is a "Close" button.

---

## Normalization area

After you perform a device normalization (as described in “Normalizing the Test Setup” on page 3-4), you can apply it to your measurements by selecting it from the main window’s Normalization area. These normalizations remove any systematic effects of the test setup from your measurements.

The following are two examples of devices for which you can create normalization data:

- A fiber jumper connected between the test ports of the CD system. Following the normalization, one end of the jumper will be disconnected and the device under test inserted.
- A pair of fiber jumpers (connected by a through adapter) connected between the test ports of the CD system. Following the normalization, the through adapter is removed and the test device inserted.

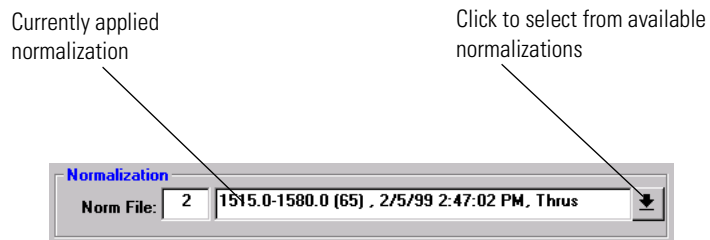

## Measurement Speed Parameters area

The Measurement Speed Parameters area allows you to adjust measurement times based upon the number of acquired measurement data points at each wavelength step. These are the measurement points used by the system's network analyzer. Of the three standard settings, the normal measurement speed setting provides the greatest accuracy and the longest measurement time. (You can enter up to 1601 data points using the custom selection.)



Under certain situations, the normal setting (201 measurement points) may not offer substantially greater accuracy than the fastest setting (3 measurement points). [Figure 2-3](#) shows how measured group-delay uncertainty varies with measurement speed, the sensitivity setting, and the loss through the test device. (To learn how the sensitivity setting affects measurement speed refer to “Sensitivity” on page 2-16.) Notice that for devices with less than 10 dB loss, very high accuracy can still be achieved using only 3 measurement points and normal sensitivity. In this situation, using more points and higher sensitivity would not gain any more accuracy but would take more time.

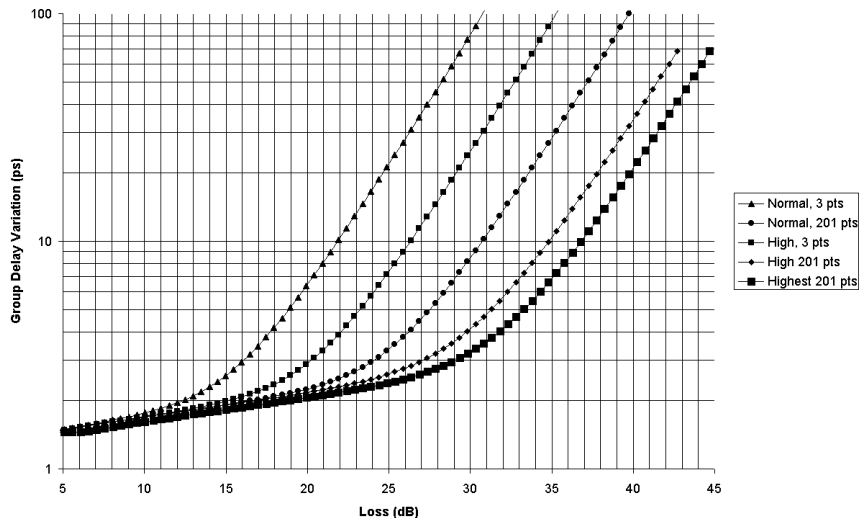

**Figure 2-3. Typical group delay uncertainty variation versus loss of test device**



By adjusting the measurement speed and sensitivity settings, you can optimize your measurements for your requirements. For example, you could design a fast test for broadband fiber measurement and a high accuracy test for narrow-band grating measurements.

---

## Fiber Related Parameters area

The two selections available in the Fiber Related Parameters area allow you to configure measurements of fiber-optic cables.

---

### Length area

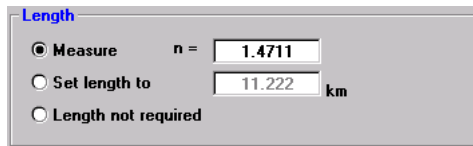

The screenshot shows a dialog box titled "Length" with three radio button options. The first option, "Measure", is selected and has a text field next to it labeled "n =" containing the value "1.4711". The second option, "Set length to", has a text field containing "11.222" followed by "km". The third option, "Length not required", is unselected.

#### ***Measure***

Enables the measurement of the length of the fiber-optic cable. Be sure to enter the cable's refractive index in the n = field.

#### ***Set length to***

Specifies the length of the fiber-optic cable in kilometers.

#### ***Length not required***

Removes the length requirement from the measurement.

---

### Repeat Cycles area

The Repeat Cycles area shows the number of times that a specific test is repeated. Click Change to change the repeat cycles values; the window shown in [Figure 2-4](#) is displayed.

You can select a single test or several groups of tests. As you move the cursor over the possible choices, they are highlighted on the diagram at the top. Delays specify the time between the end of one test or group and the beginning of the next test or group. Only the boxes applicable to the chosen test selection will be active.

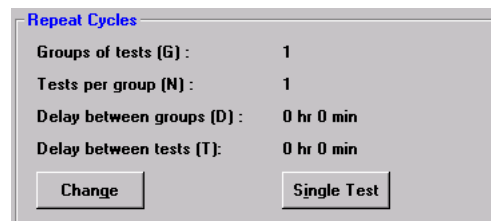

The screenshot shows a dialog box titled "Repeat Cycles" with four rows of labels and values: "Groups of tests (G) : 1", "Tests per group (N) : 1", "Delay between groups (D) : 0 hr 0 min", and "Delay between tests (T) : 0 hr 0 min". At the bottom, there are two buttons: "Change" and "Single Test".

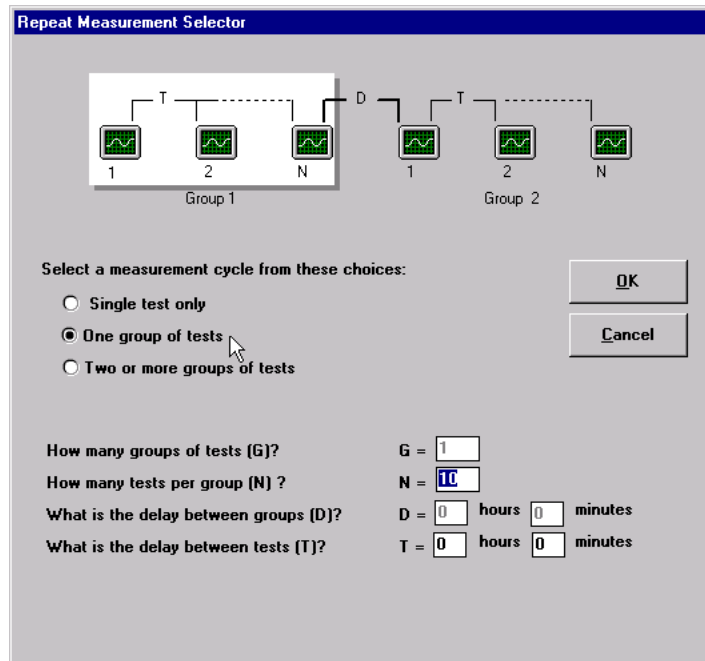

Figure 2-4. Repeat Measurement Selector

---

## Grating Related Parameters area

The Grating Related Parameters area allow you to optimize measurements for grating based devices such as fiber Bragg gratings. Options are available for improving the wavelength accuracy and measuring absolute group delay instead of the default relative group delay. For more information on measuring grating-based devices, refer to “Measuring Grating Devices” on page 1-13.

---

### TLS Wavelength Feedback Mode

If your system includes an Agilent 86120 multi-wavelength meter, you can use this area to increase wavelength accuracy of the measurement results. Measurement speed, however, will be increased. Selecting the On check box causes the multi-wavelength meter to provide wavelength feedback to the laser. The Tuning Accuracy field sets the required accuracy.

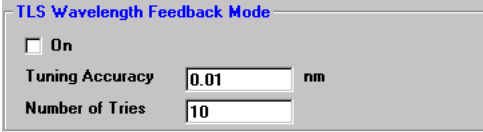

The screenshot shows a control panel titled "TLS Wavelength Feedback Mode". It contains an "On" checkbox, a "Tuning Accuracy" field with a value of "0.01" and a unit of "nm", and a "Number of Tries" field with a value of "10".

---

### Absolute Group Delay Measurement

Select On to include absolute group delay measurements to your tests. This selection automatically turns off the curve fit algorithms available in the review data window. Of course, you can still select a curve fit algorithm after the test completes if you desire. The Measurement Wavelength field allows you to set the wavelength at which the absolute group delay is measured. For narrow band grating measurements, this wavelength should be inside the passband of the filter.



The screenshot shows a control panel titled "Absolute Group Delay Measurement". It contains an "On" checkbox and a "Measurement Wavelength" field with a unit of "nm".

## File menu

Using Open Setup and Save Setup As, you can save your test setup parameters in files so that they can be recalled prior to performing a test. This makes it possible for measurements to be made without requiring detailed knowledge about the measurement parameters. And, it saves time because parameters do not have to be reentered. The .cds filename extension is automatically added to the filename.

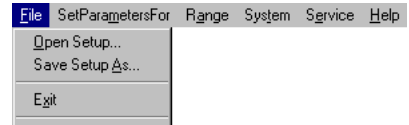

## SetParametersFor menu

### CD/Gain Meas command

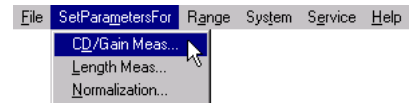

### ***Set HP Defaults button***

Sets the default settings.

### ***Test and Reference Modulation Frequencies***

Sets the RF frequencies used to modulate the optical signal during tests and reference measurements. For information on determining the optimum RF modulation frequency, refer to “Measuring Fiber Devices” on page 1-10. Use the Auto setting when

measuring devices with smooth changes in group delay such as fibers. The Manual setting is used when making measurements on grating based devices. Refer to “Measuring Grating Devices” on page 1-13.

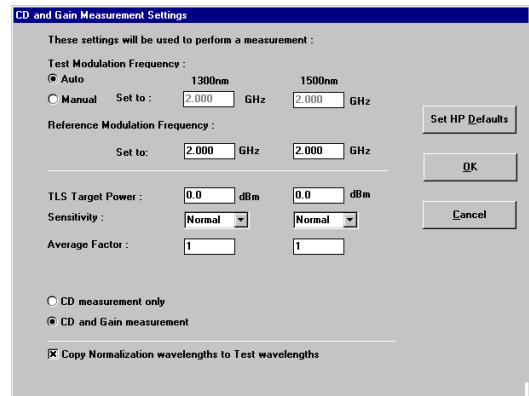

**The Main Window*****TLS Target Power***

Use this setting to specify the power level of the tunable laser source. Avoid entering power levels beyond the capability of the tunable laser source.

***Sensitivity***

You can select from Normal, High, and Highest settings. Increasing sensitivity reduces noise but increases the measurement time. The sensitivity setting configures the IF bandwidth used by the network analyzer. Normal, high, and highest correspond to 300, 100 and 30 Hz, respectively.

A measurement consisting of twenty wavelength steps might exhibit the measurement times shown in the following table.

**Table 2-2. Example Measurement Times for 20 Measurement Steps**

| <b>Sensitivity</b> | <b>Measurement Time</b> |
|--------------------|-------------------------|
| Normal             | 2 minutes, 50 seconds   |
| High               | 4 minutes, 30 seconds   |
| Highest            | 10 minutes, 5 seconds   |

***Average Factor***

Increasing the average factor reduces noise when measuring group delay. Because this factor controls the number of network analyzer sweeps which are averaged to at each wavelength point, measurement time increases in proportion to averaging factor. Noise is reduced by the reciprocal of the square root of the averaging factor.

***CD measurement only or CD and Gain measurement***

Click these options to include gain measurements during your testing. For measurements on fibers, the chromatic dispersion measurement is typically the only measurement of interest. For measurements on filters or systems containing optical amplifiers you may be interested in the passband of the device under test because the chromatic dispersion data is meaningful only within the passband. Selecting the CD and Gain measurement option increases the measurement time.

**Table 2-3. Example Measurement Times for 20 Measurement Steps**

| Test                    | Measurement Time      |
|-------------------------|-----------------------|
| CD measurement only     | 2 minutes, 50 seconds |
| CD and Gain measurement | 3 minutes, 46 seconds |

***Copy Normalization wavelengths to Test wavelengths***

Use this selection to copy the calibration wavelength limits to the wavelengths used for the measurement. If the values are identical, this feature eliminates the need to enter the wavelength limits twice.

**Length Meas command**

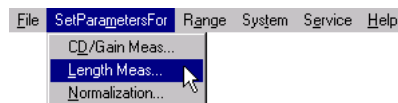

***HP Defaults***

This button sets the dialog box to its default settings.

***TLS Wavelength and TLS Target Power***

Edit these fields to set the wavelength and power level of the tunable laser source. If the specified power level is too high for the tunable laser source, the tunable laser source supplies as much as is possible.

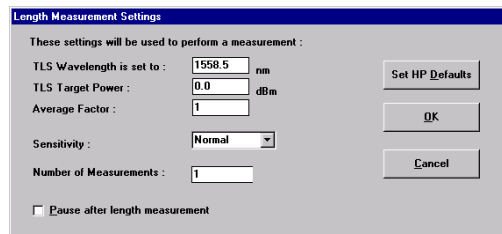

***Average Factor***

Increasing the average factor reduces noise when measuring length. Because this factor controls the number of network analyzer sweeps which are averaged to at each wavelength point, measurement time increases in proportion to averaging factor. Noise is reduced by the reciprocal of the square root of the averaging factor.

***Sensitivity***

You can select from Normal, High, and Highest settings. Increasing sensitivity reduces noise but increases the measurement time. The sensitivity setting configures the IF bandwidth used by the network analyzer. Normal, High, and Highest correspond to 300, 100, and 30 Hz, respectively.

Operation  
**The Main Window**

***Number of Measurements***

Use this entry to set the number of measurements required to determine the length.

---

**Normalization command**

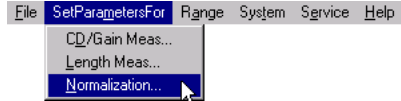

Refer to Chapter 3, “Normalization” for information on using the Normalization command.

---

**Range menu**

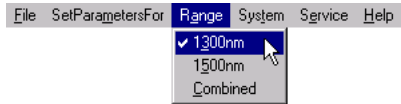

On dual-band systems, use the selections in the Range menu to select the measurement band. Single-band systems do not provide this menu.



---

## System menu

---

### Addresses command

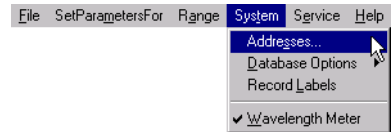

On the System menu, click Addresses to view the GPIB addresses for all of the instruments in the system. These addresses are set at the factory and should not be changed.

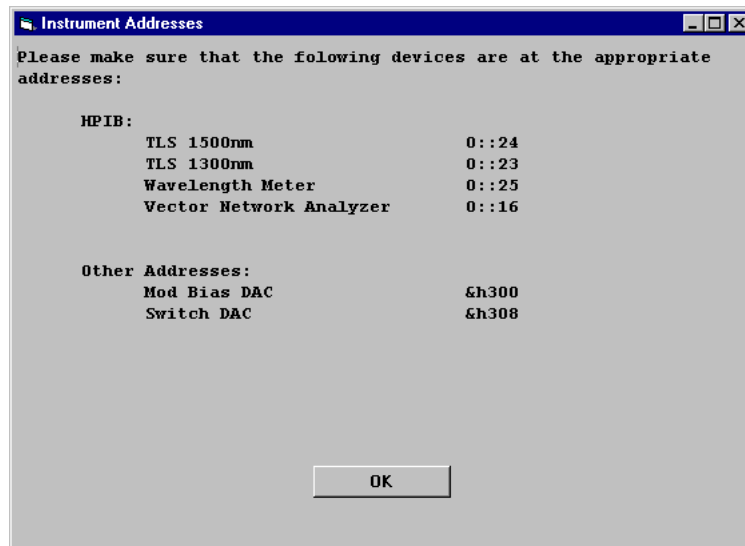

---

### Database Options command

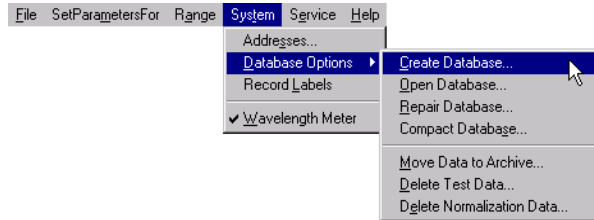

The Agilent 86037B places settings and measurement results in a database. To learn about managing the database, refer to “Using Database Files” on page 2-32.

---

### Record Labels command

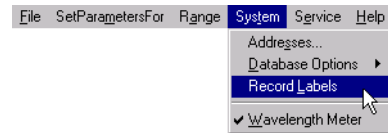

Using the Record Labels command, you can change the test identification labels to suit your needs. [Figure 2-5 on page 2-21](#) shows an example of changing several of these labels.

---

### Wavelength Meter command



Click Wavelength Meter to set or clear the check mark indicating that the system includes a wavelength meter.

To change these labels

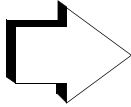

Fiber :   
Cable :   
Segment :   
Test Manager :  < Edit names  
Operator :  < Edit names  
Temperature :  °C  
Remarks :

**System Preferences**

Device name 1 :   
Device name 2 :   
Device name 3 :   
Test Manager :   
Operator :   
Temperature :   
Remarks :

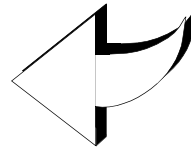

Click Edit names, and edit the fields in the dialog box

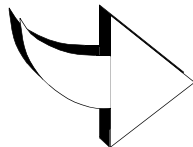

Grating :   
Device # :   
Run # :   
Test Manager :  < Edit names  
Technician :  < Edit names  
Temperature :  °C  
Remarks :

**Figure 2-5. Changing the test information labels**

---

## Service menu

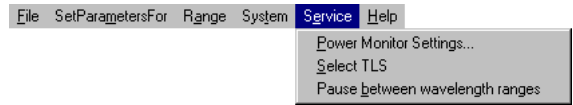

### ***Power Monitor Settings command***

The settings entered with this command are normally changed once when the system is first installed. Refer to “Adjusting the Power Monitor” on page 3-10 for a description on using this command.

### ***Select TLS command***

This command turns the appropriate tunable laser source on or off. For safety reasons, the system is shipped from Agilent with the lasers set to off.

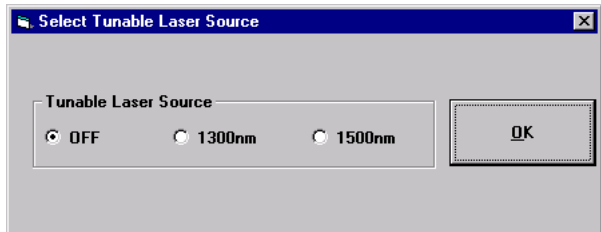

### ***Pause between wavelength ranges command***

Click Pause between wavelength ranges command to set or clear the check mark. When set, a short delay is added between measuring different wavelength ranges.



## The Review Data Window

Clicking Review Data in the main window displays the Review Data window for viewing your measurement data. To return to the main window, simply click the Return to Main button. See [Figure 2-7 on page 2-24](#).

From the Review Data window, you can select from five different presentations of your data. Each view is selected by clicking one of five tabs. Two tabs present gain data, if measured. To enable gain measurements, use the appropriate item in the CD/Gain Meas command. Refer to “CD measurement only or CD and Gain measurement” on page 2-16.

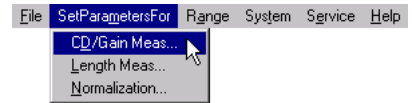

Using the normalize dispersion button, you can change the y-axis data on the review data graphs. This button toggles between showing chromatic dispersion data for the total measured path and showing the chromatic dispersion of the path divided by the path length (in km). These two selections are shown in [Figure 2-6](#).

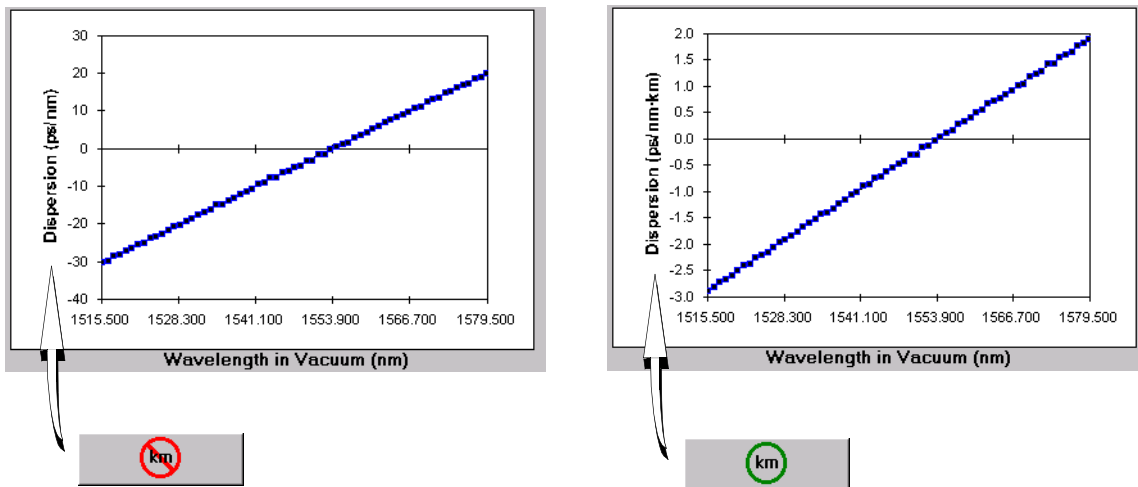

**Figure 2-6. The normalize dispersion button**

## Operation The Review Data Window

① Menu bar

⑤ Select curve fit algorithm for group delay

④ Print measurement results

Return preferred wavelengths to default values

Normalize dispersion by length in km

Return to main window

② Five tabs showing alternate views of measurement data

③ Data listed at eight user preferred wavelengths

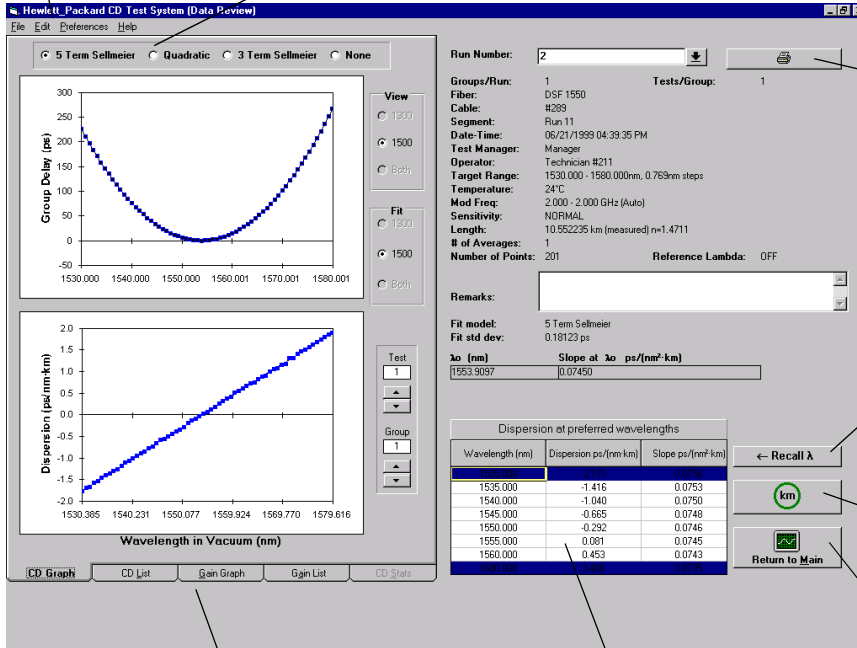

**Figure 2-7. The Review Data Window**

| Window Area | Refer to...  |
|-------------|--|
| ①           | "File menu" on page 2-29 through "Preferences menu" on page 2-31 |
| ②           | "Measurement review tabs" on page 2-25                           |
| ③           | "Preferences menu" on page 2-31                                  |
| ④           | "Print command" on page 2-29                                     |
| ⑤           | "The curve fit selection" on page 2-28                           |

## Measurement review tabs

### *The CD Graphs tab*

This view displays two graphs of the measurement results. The top graph shows the relative group delay points and fitted curve. The bottom graph shows the computed dispersion. Dispersion points are computed from pairs of group delay points and are displayed midway between the corresponding wavelengths. The smooth dispersion curve is derived from the fitted group delay curve. Length normalization can be selected at any time by clicking km.

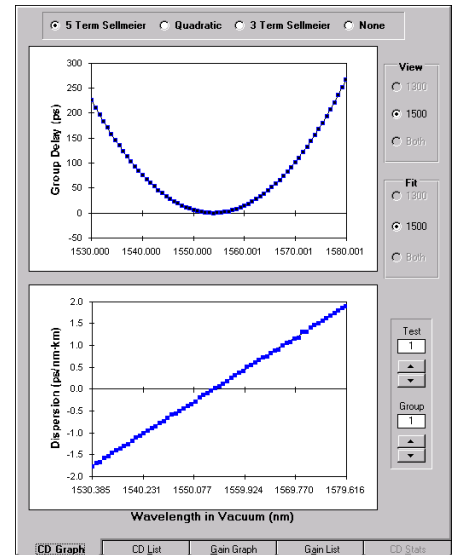

### *The CD List tab*

This view displays the measurement results in tabular form. If a multi-wavelength meter was used in the measurement setup, the actual measured wavelengths is displayed. Length normalization can be selected at any time by clicking km.

The Dispersion (meas.) column of data is the directly calculated dispersion obtained by calculating the slope of the group delay with respect to wavelength, as follows:

$$\text{Dispersion (meas.)} = \Delta\tau / \Delta\lambda$$

Where,  $\Delta\tau$  is the measured difference in group delay, and  $\Delta\lambda$  is the difference in wavelength between adjacent points. These data points will appear to be noisy when the wavelength step size is less than about 1 nm, because the wavelength step is in the denominator of the calculation. Therefore a small wavelength step tends to amplify any noise in the group delay data.

**The Review Data Window**

The amount of scatter of the directly calculated dispersion has minimal impact on the accuracy of the zero-dispersion wavelength because the zero-dispersion wavelength is obtained from the fitted curve. When the wavelength step is very small (less than about 0.01 nm), and a wavelength meter is used with the system, it is possible for two or more data points to have the same wavelength due to imperfect tuning of the tunable laser source. When this happens, it is no longer possible to directly calculate the dispersion from adjacent group delays because the denominator in the above equation is zero. In such cases, the dispersion is calculated by using the last data point of the group of data with the same wavelength. However, when the group delay data is automatically stored in the database, all points are saved.

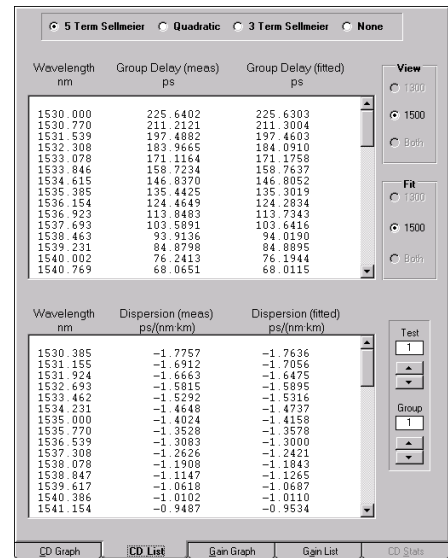
***The Gain Graphs and List tabs***

These tabs show the measured gain and (for reference) the measured relative group delay. The information from the Gain Graphs and the Gain List tabs can be viewed only if both the CD and gain measurements have been performed. In the graphs, the displayed points are connected by straight line segments, with no curve fitting.

If a wavelength meter was used in the measurement setup, the actual measured wavelengths are displayed.



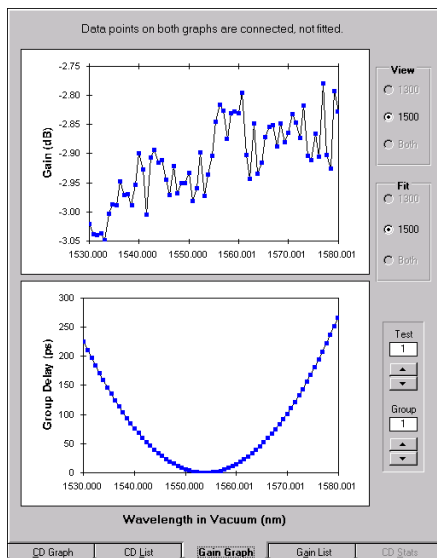

| Wavelength nm | Gain dB | Group Delay (meas) ps |
|---------------|---------|-----------------------|
| 1530.000      | -3.022  | 225.6402              |
| 1530.770      | -3.039  | 211.2131              |
| 1531.539      | -3.039  | 197.4982              |
| 1532.308      | -3.037  | 183.9665              |
| 1533.078      | -3.048  | 171.1164              |
| 1533.846      | -3.003  | 158.7234              |
| 1534.615      | -2.988  | 146.8370              |
| 1535.385      | -2.989  | 135.4425              |
| 1536.154      | -2.948  | 124.4649              |
| 1536.923      | -2.971  | 113.8483              |
| 1537.693      | -2.970  | 103.5891              |
| 1538.463      | -2.989  | 93.9136               |
| 1539.231      | -2.954  | 84.8798               |
| 1540.002      | -2.900  | 76.2413               |
| 1540.769      | -2.927  | 68.0651               |
| 1541.539      | -3.005  | 60.3564               |
| 1542.309      | -2.906  | 53.0455               |
| 1543.077      | -2.894  | 46.1168               |
| 1543.846      | -2.916  | 39.8036               |
| 1544.615      | -2.911  | 33.9082               |
| 1545.384      | -2.944  | 28.5752               |
| 1546.155      | -2.971  | 23.8477               |
| 1546.923      | -2.921  | 19.3419               |
| 1547.692      | -2.968  | 15.3368               |
| 1548.463      | -2.951  | 11.7095               |
| 1549.231      | -2.951  | 8.6625                |
| 1550.000      | -2.933  | 5.8724                |
| 1550.770      | -2.982  | 3.5668                |
| 1551.538      | -2.960  | 1.9608                |
| 1552.308      | -2.897  | 0.9105                |
| 1553.076      | -2.973  | 0.3939                |
| 1553.847      | -2.936  | 0.0000                |
| 1554.615      | -2.903  | 0.2457                |
| 1555.386      | -2.846  | 0.7915                |
| 1556.154      | -2.817  | 1.8479                |
| 1556.922      | -2.827  | 3.2939                |
| 1557.693      | -2.875  | 5.4481                |

**The CD Statistics tab**

The displayed results give a statistical analysis of a single group of two or more tests. The top table lists the statistics for  $\lambda_0$  (lambda zero) and the dispersion slope at  $\lambda_0$ . The numbers of the tests from which maximum and minimum values are taken are shown in parentheses beside the listed values. The Sample cell indicates the number of tests which exhibited a value of  $\lambda_0$  equal to or near the displayed value. If the measurements produced multiple values of  $\lambda_0$  that differ substantially, these values and the corresponding dispersion slopes, can be viewed by adjusting the scroll bar below the display.

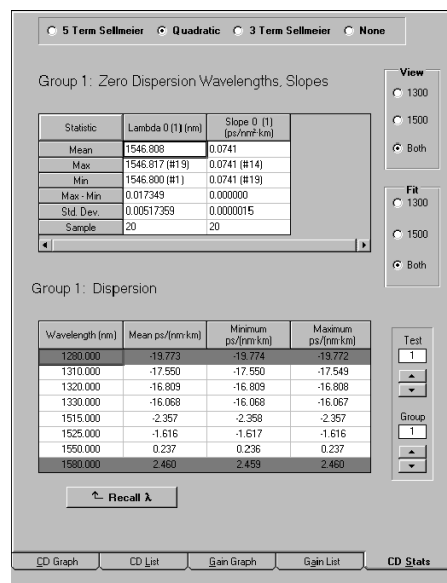

The lower table shows the dispersion statistics at a series of user-selectable wavelengths. Wavelengths falling outside of the measurement range are shown in red. The dispersion values listed are computed from the curve fitted

**The Review Data Window**

to the relative group delay measurements. Use the option buttons above the tables to change the type of curve fit. The statistics for the five-term Sellmeier fit can contain multiple zero-dispersion wavelengths. To view them, scroll horizontally across the displayed data.

***The curve fit selection***

Curve fitting algorithms improve the measurement precision of chromatic dispersion measurements.



5 Term Sellmeier    Quadratic    3 Term Sellmeier    None

Even in fiber, some noise is present with the group delay and, since dispersion is the derivative of the group delay, the effect of any noise is exaggerated. The dispersion at any wavelength can be calculated from a fitted curve which, by definition, has no noise.

These curve fit algorithms are primarily meant for measurements made on fiber based devices. If you select Absolute Group Delay Measurement in the Grating Related Parameters area in the main window, the curve fit selection will automatically be set to none.

- The quadratic curve fit is commonly used for dispersion-shifted fiber, in which waveguide dispersion is dominant.
- The 3 term Sellmeier curve fit is commonly used for dispersion-unshifted fiber in which material dispersion plays the major role.
- The 5 term Sellmeier curve fit, although more affected by noise and instabilities in the measurement path, provides more general purpose curve fitting. The five-term Sellmeier fit can yield multiple zero-dispersion wavelengths. All the values and their associated slopes are shown in the graphs. The system searches for dispersion zeros in a wavelength range equaling approximately five times the measurement span (2.5 times each side of the center wavelength). This allows identification of zero-dispersion wavelengths which fall outside of the measurement range. In some cases, due to the peculiarity of the five-term Sellmeier fit, zero-dispersion wavelengths found outside of the measurement range may not correspond to actual zero-dispersion wavelengths of the device under test.

## File menu

### ***Print command***

The Print command displays the Print Range dialog box from which you can print the measurement results. You can select items to be included when printed.

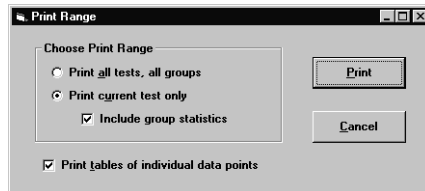
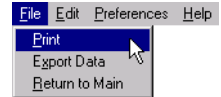

### ***Export Data command***

You can easily export your measurement results to your spreadsheet application or word processor. To create a spreadsheet file, click Export Data from the File menu. Spreadsheet files are ASCII files that can be imported into any popular spreadsheet application for further analysis. When you save (export) the file, you select the data included in the file along with the delimiter character used between data entries. Refer to the documentation that came with your spreadsheet application to determine the preferred delimiter. Most spreadsheet applications use either a comma or tab character. [Table 2-4 on page 2-30](#) describes each data field that can be exported to a spreadsheet file. To copy data to your word processor, you can also use the Windows NT clipboard as described in “Edit menu” on page 2-31.

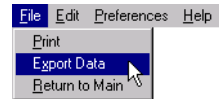

- 1 Click File, Export Data.
- 2 Enter the destination filename, and press the Enter key.
- 3 Click Edit Format.
- 4 Select the data included in the file and the format for the data.
- 5 Click OK.

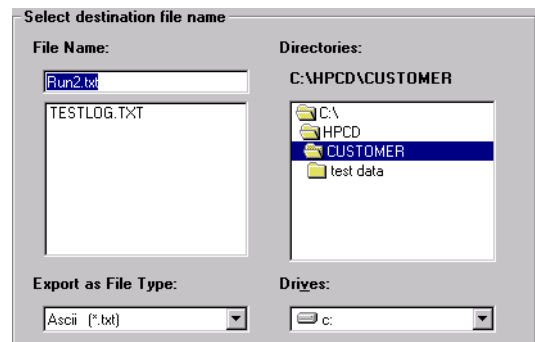

**The Review Data Window**

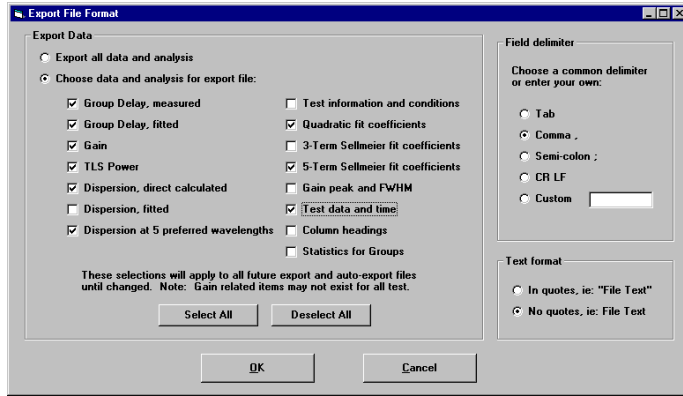

**Table 2-4. Data Included in Spreadsheet File**

| Data Type                             | Description   |
|---------------------------------------|---|
| Group Delay, measured                 | List of measured group delay in raw data format.  |
| Group Delay, fitted                   | List of measured group delay using the curve fit selected in the Data Review view.  |
| Gain                                  | List of gain measured at each wavelength. Only available if a gain measurement was performed as part of the test run.                               |
| TLS Power                             | TLS power setting.  |
| Dispersion, direct calculated         | List of directly calculated dispersion values, with no curve fitting.   |
| Dispersion, fitted                    | List of dispersion values, with the appropriate curve fit selected in the Data Review view.   |
| Dispersion at 5 preferred wavelengths | List of selected wavelengths chosen in the Data Review view.  |
| Test information and conditions       | List of the data found on the right hand side of the Data Review view, dealing with test conditions.  |
| Quadratic fit coefficients            | Relevant fit coefficients.  |
| 3-Term Sellmeier fit coefficients     |   |
| 5-Term Sellmeier fit coefficients     |   |
| Gain Peak and FWHM                    | Measured Gain Peak and Full Width, Half Max. values. This option is only available if the a gain measurement was performed as part of the test run. |
| Test Data and Time                    | Time, date, supervisor, and user information.   |
| Column Headings                       | Includes label for each column of data.   |
| Statistics for Groups                 | All information shown in the CD Stats tab of the Data Review view.  |

## Edit menu

You can use the edit menu to copy chromatic dispersion measurement data to the Windows NT clipboard. Once the data is copied to the clipboard, you can easily paste it into other applications such as a word processor.



- 1 In the Review Data view, click on the CD List or Gain List tabs.
- 2 Highlight the section of data to be copied.
- 3 Press Ctrl-C on the keyboard to copy the highlighted content into the clipboard.
- 4 Start your word processor.
- 5 Position the cursor at the appropriate point in the text editor, and press Ctrl-V.

## Preferences menu

### *Data Presentation command*

Using the Data Presentations command, you can specify the eight preferred wavelengths that are displayed in the table on the Data Review Window. These wavelengths do not need to be at a directly calculated data point. The displayed value is calculated using the selected curve fit. However, if a preferred wavelength is outside the measurement range, the results are indicated in red.

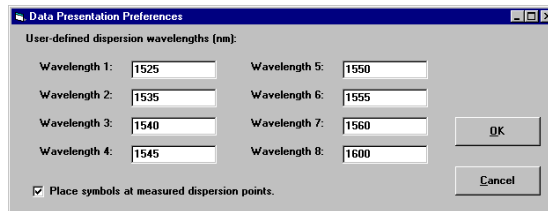
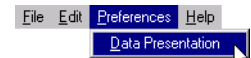

Even though the preferred wavelengths are set, you can still type a wavelength directly into the table to view its values. In the Data Review Window, click Recall  $\lambda$  to return the wavelengths to your preferred values.

---

## Using Database Files

The Agilent 86037B maintains all measurement results and settings in a database. The initial database is located in the hpcd/customer folder on the computer's drive C. Until you create a new database, results for each of your measurements will be contained in this initial database file. New database files must be placed in a new folder.

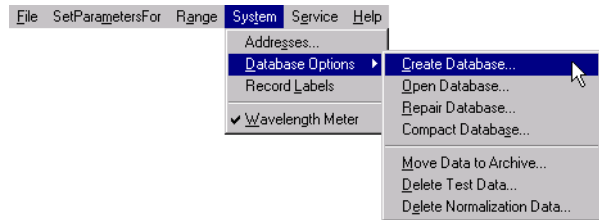

The system always operates with an open database. You can change the open database at any time. After opening a new database, the calibration files, devices, test operator, manager's names, and test data from the previous database are no longer available. To make them available, select the previous database directory.

The information in the database, including measurement results, can be read and modified using a database tool such as Microsoft Access. For information on remote programming of the system through the database, refer to Chapter 4, "Remote Control".

### ***Repair Database command***

If an error occurs while you are trying to open a database, the database file is damaged and must be repaired before it can be opened. Damaged data will be removed during the repair process and is permanently lost and unrecoverable. However, repairing an undamaged database file causes no harm and no data is lost. The database repair function returns a warning if the database file is read only.

The repair function operates on any database file *other than one that is currently open*. During a repair, the database file is compacted, which can result in a file that is smaller than the original.

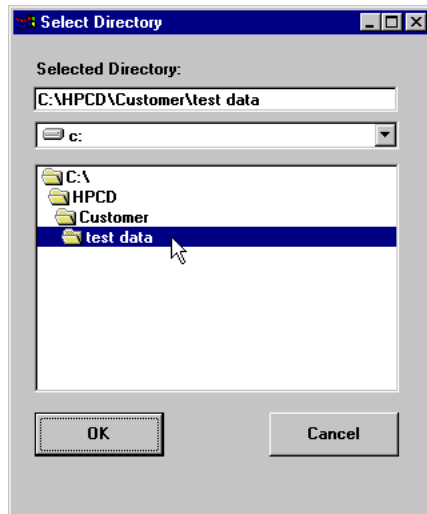

### ***Move Data to Archive command***

Large database files are slow and require time to store and retrieve data. The database archive feature helps you manage the size of your database files by moving test data from the currently opened database file to another database file.

For example, you can create a database file on a floppy disk and then move some tests from the system to the floppy disk for storage or transport to another system. You will be asked if you wish to delete the tests after they have been moved. A database file must be open before it can be archived.

## Using Database Files

**Move Test Data To Archive By Run**

| Run | Range         | Date/Time      | Fiber    | Cable     | Segment      | Grp/Run | Tst/Grp |
|-----|---------------|----------------|----------|-----------|--------------|---------|---------|
| 13  | 1500nm        | 09/30/98 23:44 | DSF 1550 | #308 Ref2 | Cal 1 Run 12 | 1       | 10      |
| 9   | 1300nm,1500nm | 09/30/98 22:14 | DSF 1550 | #308 Ref2 | Cal 1 Run 7  | 2       | 3       |
| 12  | 1300nm,1500nm | 09/30/98 22:53 | DSF 1550 | #308 Ref2 | Cal 1 Run 12 | 1       | 1       |
| 11  | 1300nm        | 09/30/98 22:47 | DSF 1550 | #308 Ref2 | Cal 1 Run 11 | 1       | 1       |
| 10  | 1300nm        | 09/30/98 22:43 | DSF 1550 | #308 Ref2 | Cal 1 Run 10 | 1       | 1       |
| 8   | 1300nm,1500nm | 09/30/98 21:46 | DSF 1550 | #308 Ref2 | Cal 1 Run 7  | 2       | 3       |
| 7   | 1300nm,1500nm | 09/30/98 18:19 | DSF 1550 | #308 Ref2 | Cal 1 Run 7  | 5       | 10      |
| 6   | 1300nm        | 09/30/98 17:48 | DSF 1550 | #308 Ref2 | Cal 3 Run 5  | 1       | 1       |

In order to view archived data bases, they must be in a folder with an appropriate TestParm.mdb.

First run set to 0  
 Last run set to 0

### ***Compact Database command***

A currently opened database file can be compacted to reduce the amount of disk space it occupies. A database file must be open before it can be compacted. The function returns an error if the database file is read-only. Compacting is automatically performed when a database file is repaired.



---

## Checking Test Fiber Stability

Changes in environmental temperature can affect the length of the fiber-optic cables that you are testing. Because changes in length degrade measurement results, use this procedure to determine if the fiber-optic cable has stabilized and is ready to test. For information on the theory behind this test, refer to the sidebar “Measurement theory” on page 2-37.

- 1** Connect a patch cord “through” cable between the SOURCE OUTPUT and RECEIVER INPUT.
- 2** Click **Modulator Bias** and then click **OK**.
- 3** When the modulator bias adjustment is complete, remove the thru fiber and connect the fiber to be tested between the test ports.
- 4** On the front panel of the Agilent 8168 tunable laser source, press the **LOCAL** key.

When you complete this procedure and return to using the mouse or keyboard, control of the instruments return to the Agilent 86037B. The network analyzer and tunable laser source are automatically initialized for all of the system measurements.

- 5** Verify the laser output power is set to at least  $-4$  dBm at a wavelength in the passband of the fiber-optic cable that you are testing.
- 6** On the front panel of the Agilent 8753 network analyzer, press the **LOCAL** key.
- 7** Enter the CW frequency by pressing: *MENU*, *CW FREQ*, and *1 G/n*.
- 8** Enter the number of points by pressing: *MENU*, *NUMBER of POINTS*, and then *401 X1*.
- 9** Enter a convenient sweep time, such as 60 seconds, by pressing: *MENU*, *SWEEP TIME*, and then *60 X1*.
- 10** Press *MENU*, *TRIGGER MENU*, and *CONTINUOUS*.
- 11** Press *MENU* and then *MEASURE RESTART*.
- 12** Wait until the first sweep is complete, and then press: *SCALE/REF* and then *AUTOSCALE*.

### Checking Test Fiber Stability

The displayed trace is a history of the modulation phase over the selected time period (sweep time).

- 13** Press SCALE/REF, and enter a value in degrees that is equal to the fiber-optic cable's index of refraction. For example, if the index of refraction is 1.45, enter 1.45°. Now, each vertical division corresponds to 1 mm of drift in the length of the cable.

If you set the Scale/Div to 0.36 degrees, each vertical division corresponds to 1 ps of drift in the group delay.

- 14** You can save this setup, so it is available when making length stability measurements in the future.

- a** Press SAVE and then SAVE REG#.
- b** Press SAVE and then TITLE REGISTER#.
- c** Enter a title and then press DONE and then RETURN.
- d** Press: SAVE **your title**.

- 15** To recall a previously stored setup:

- a** Press: RECALL and then RECALL **your title**.
- b** Adjust the vertical axis of the display, press: SCALE/REF and then SCALE/DIV or REFERENCE VALUE or AUTOSCALE.

### Measurement theory

Stability is examined by measuring modulation phase at the output of the test fiber relative to the electrical modulation source, as a function of time. The change in group delay required to produce a change in modulation phase is given by:

$$\Delta\tau = \frac{\text{Change in phase}}{360 \times \text{Modulation Frequency}}$$

In convenient units, this equation becomes:

$$\Delta\tau \text{ (ps)} = \frac{\text{Change in phase (degrees)}}{\text{Modulation Frequency (GHz)}}$$

An observed phase change of 0.36 degrees at a modulation frequency of 1 GHz is evidence of a 1 ps change in the group delay of the test fiber. For convenience, you can set the scale/div to 0.36 degrees so each vertical division corresponds to 1 ps of drift in the group delay.

If you prefer to analyze the stability of the test fiber in terms of length, use the following equation:

$$\Delta L \text{ (mm)} = \frac{\text{Change in phase (degrees)}}{n \times \text{Modulation Frequency (GHz)}}$$

Using this equation, an observed phase change of 1.45 degrees at a modulation frequency of 1 GHz is evidence of a 1 mm change in the length of the test fiber, assuming a refractive index, *n*, of 1.45. For convenience, set the Scale/Div to 1.45 degrees so that each vertical division corresponds to 1 mm of drift in the length of the test fiber.



|                                      |      |
|--------------------------------------|------|
| Normalizing the Test Setup           | 3-4  |
| Verifying a Test Setup Normalization | 3-6  |
| Adjusting the Modulator Bias         | 3-7  |
| Normalizing the Laser                | 3-8  |
| Adjusting the Power Monitor          | 3-10 |
| Setting Normalization Preferences    | 3-13 |

---

## Normalization

## Normalization

Normalization removes any systematic effects of the test setup from the measurements. The normalization path must include any fiber-optic patch cables used to connect the device being tested to the front-panel SOURCE OUTPUT and RECEIVER INPUT connectors. As [Table 3-1](#) shows, there are two different normalization procedures and two adjustments that are necessary.

**Table 3-1. Recommended Interval between Normalizations and Adjustments**

| <b>Procedure</b>          | <b>Recommended Interval</b>   |
|---------------------------|---|
| Test setup normalization  | Once a day or before any critical measurement. Refer to “Normalizing the Test Setup” on page 3-4.   |
| Modulator bias adjustment | Before any measurement session. You can select to have this adjustment procedure run automatically whenever a device normalization is performed. Refer to “Adjusting the Modulator Bias” on page 3-7. |
| Laser normalization       | When the system is installed or the tunable laser source is replaced. Refer to “Normalizing the Laser” on page 3-8.   |
| Power monitor adjustment  | When system is installed or the tunable laser source is replaced. Refer to “Adjusting the Power Monitor” on page 3-10.  |

The laser normalization and power monitor adjustments should be performed when the system is installed. They do not need to be performed before each individual measurement. You should perform the test setup normalization once a day, unless the system has been turned off since the last test setup normalization. The modulator bias adjust can be automatically configured to run each time a test setup normalization is performed.

Because normalization data is saved in a file, it can be recalled and used at a later time. It is sometimes possible to use normalization files four or five days old and still obtain good measurement results. When in doubt, click the Normalization Verification button to quickly check the quality of the normalization.

### ***Test setup normalization***

The following are two examples of devices for which you can create normalization data:

- A fiber jumper connected between the test ports of the CD system. Following the normalization an end of the jumper will be disconnected and the device under test inserted.
- A pair of fiber jumpers (connected by a through adapter) connected between the test ports of the CD system. Following the normalization, the through adapter is removed and the test device inserted.

### ***Modulator bias adjustment***

Perform the modulator bias adjustment at the beginning of a measurement session. The modulator is automatically biased to the optimum (quadrature) performance condition. This procedure does not need to be performed before each individual measurement, and can be set to occur automatically when a normalization is performed.

### ***Laser normalization***

This procedure normalizes the system between 1515 nm and 1580 nm, in 1 nm steps. Correction constants are determined for the laser and stored. Perform this procedure when the system is installed; it does not need to be performed before each individual measurement.



## Normalizing the Test Setup

- 1 Click New Normalization.

A screenshot of a software dialog box titled "New Normalization". It features a "Select Normalization Device" dropdown menu with "Thrus" selected. Below this are two columns of input fields for "1300nm" and "1500nm". The "1500nm" fields are highlighted in blue. The fields are: Start Wavelength (1280.0, 1515.0 nm), Stop Wavelength (1330.0, 1580.0 nm), Number of Steps (50, 65), and Step Wavelength (1.0, 1.0 nm). On the right side, there are three buttons: "Add Normalization Device", "Start Normalization", and "Close". At the bottom, there is a checked checkbox labeled "Adjust modulator bias before starting normalization".

|                               | 1300nm | 1500nm |    |
|-------------------------------|--------|--------|----|
| Select Normalization Device : | Thrus  |        |    |
| Start Wavelength :            | 1280.0 | 1515.0 | nm |
| Stop Wavelength :             | 1330.0 | 1580.0 | nm |
| Number of Steps :             | 50     | 65     |    |
| Step Wavelength :             | 1.0    | 1.0    | nm |

Adjust modulator bias before starting normalization

- 2 Select the name of the normalization device from the Select Normalization Device field or highlight a name in the list box. To add another normalization device, click on Add Normalization Device. Repeat this step for each device that you wish to add.

If you change the wavelength values and then click Add Normalization Device, the wavelength values reset to the default values and must be reentered.

- 3 Enter the start and stop wavelengths in the appropriate fields.
- 4 Enter the number of steps or step wavelength.
- 5 To adjust the modulator bias before performing a normalization, click Adjust modulator bias before starting normalization. Enabling this selection is recommended.
- 6 Connect the chosen normalization device.



---

**CAUTION**

---

Before making the fiber connections, read the section on “Cleaning Connections for Accurate Measurements” on page 5-20.

- 7 Start the normalization by clicking the Start Normalization.

A normalization takes 5 to 10 minutes to complete, depending on the number of steps selected. During normalization, the status message “Normalizing. Please stand by...” is shown at the bottom of the display. The data monitor graph is visible during actual collection of the normalization data. When the normalization is completed, message “Ready” is displayed.

- 8 If no other normalization are required, close the normalization window and continue with your measurement.



## Verifying a Test Setup Normalization

Before a measurement session, it is a good idea to verify the current normalization. Verification does not need to be performed before each measurement.

- 1 Connect the appropriate normalization device, such as a short fiber-optic cable, between the SOURCE OUTPUT and RECEIVER INPUT connectors.

### CAUTION

Use fiber-optic patch cords to connect the test set SOURCE OUTPUT and RECEIVER INPUT to either a device being tested or a short test cable to protect the test set fiber connectors from undue and unnecessary wear.

- 2 Select the desired normalization file in the normalization menu. Enter its number in the Norm File: box or select it from the drop-down list.

| Norm | Date/Time      | Start-1300 | Stop-1300 | Steps-1300 | Start-1500 | Stop-1500 | Steps-1500 | Device |
|------|----------------|------------|-----------|------------|------------|-----------|------------|--------|
| 2    | 02/05/99 14:47 |            |           |            | 1515.0     | 1580.0    | 65         | Thrus  |
| 1    | 02/05/99 08:46 | 1280.0     | 1330.0    | 50         |            |           |            | Thrus  |

**Figure 3-1. Normalization File Section of the Main Window**

- 3 Click Verify Normalization. The system performs a modulator bias adjustment. Then it measure ten group delay points in the measurement span and checks the maximum group delay against the limit set in the Normalization Settings window of the SetParametersFor menu.

On completing the verification, a message indicates if the normalization verification has passed or failed. It also shows the maximum group delay value obtained during the verification. The system group delay noise floor can vary between 0.05 ps and 2 ps. You can set the limits by selecting Normalization in the SetParametersFor menu.

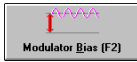

---

## Adjusting the Modulator Bias

- 1** On the System menu, confirm that the Wavelength Meter command is checked. The checkmark can be toggled on and off by clicking the command.
- 2** Connect a short "through" fiber-optic cable between the front-panel SOURCE OUTPUT to RECEIVER INPUT connectors.
- 3** Click the Modulator Bias button.

---

## Normalizing the Laser

- 1 Allow the system to warm up for two hours.
- 2 Connect a short "through" fiber-optic cable from the SOURCE OUTPUT to the RECEIVER INPUT connectors.
- 3 On the Service menu, click Select TLS.
- 4 In the displayed dialog box, click the appropriate button to enable the tunable laser source. For safety reasons, the default value is OFF.

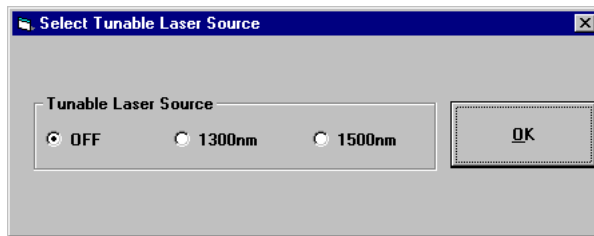

- 5 On the SetParametersFor menu, click CD/  
Gain Meas. In the dialog box, click Set HP  
Defaults and then click OK.
- 6 Click New Normalization.

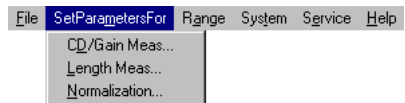

**New Normalization**

Select Normalization Device :

Thrus

|                    | 1300nm | 1500nm |    |
|--------------------|--------|--------|----|
| Start Wavelength : | 1280.0 | 1515.0 | nm |
| Stop Wavelength :  | 1330.0 | 1580.0 | nm |
| Number of Steps :  | 50     | 65     |    |
| Step Wavelength :  | 1.0    | 1.0    | nm |

Adjust modulator bias before starting normalization

- 7 Select the name of the normalization device from the Select Cal Device field or highlight a name in the list box. To add another normalization device, click on Add Normalization Device.
  - 8 Confirm that the start and stop wavelengths are 1515 nm and 1580 nm and that the step wavelength is 1nm.
  - 9 If you wish to adjust the modulator bias before starting the normalization, click Modulator Bias before starting a normalization.
  - 10 Click Start Normalization to start the normalization.
- A normalization can takes approximately 10 minutes to complete. During normalization, the message area at the bottom of display shows Normalization . Please stand by.
- 11 When the graph display closes and the message area indicates Ready, close the New Normalization window.
  - 12 Click Verify Normalization to confirm that the normalization data is valid.

If the verification does not pass, note the maximum group delay value obtained, and report the failure to Agilent Technologies.



## Adjusting the Power Monitor

Perform this procedure when the system is first installed; it does not need to be performed before each individual measurement. In the following procedure, you'll need an optical power meter.

- 1 On the System menu, confirm that the Wavelength Meter command is checked. The check mark can be toggled on and off by clicking the command.
- 2 Connect a short "through" fiber-optic cable between the front-panel SOURCE OUTPUT to RECEIVER INPUT connectors.
- 3 Click the Modulator Bias button.

The modulator is automatically biased to the optimum (quadrature) performance condition. Bias adjustment is performed at the beginning of a measurement session. It does not need to be performed before each individual measurement. Bias adjustment can be set to occur automatically when a normalization is performed.

- 4 On the Service menu, click Power Monitor Settings.

For dual band systems, enter high band values in the following steps. If you have a single band system, perform these steps to enter the values for the single available band.

|                            | 1300nm   |     | 1500nm   |     |
|----------------------------|----------|-----|----------|-----|
| Power constant :           | 2.031    | dB  | -2.702   | dB  |
| Under range limit :        | -43.0    | dBm | -43.0    | dBm |
| Insertion loss reference : | -9.264   | dB  | -11.235  | dB  |
| TLS power :                | -4.0     | dBm | 0.0      | dBm |
| TLS wavelength :           | 1308.000 | nm  | 1558.500 | nm  |

**Figure 3-2. Power Monitor Setup Window**

**Adjusting the Power Monitor**

- 5 Enter 0.0 in the Power constant field. Click OK.
- 6 Press the Local key on the TLS (tunable laser source) to put it in local operation mode.
- 7 On the TLS, set the wavelength to 1558.5 nm and the power to 0 dBm.
- 8 Connect a short fiber-optic cable from the SOURCE OUTPUT connector to an optical power meter. Press the Active key on the tunable laser source.
- 9 Measure the optical power at 1558.5 nm on the power meter and record the reading  $P_1$ .

$P_1$ : ..... \_\_\_\_\_ dBm

- 10 Disconnect the fiber-optic cable from the power meter and connect it to the RECEIVER INPUT port on the Agilent 83427A test set.

- 11 Click the Power Monitor button on the main window and record the power reading  $P_2$ .

$P_2$ : ..... \_\_\_\_\_ dBm

- 12 Calculate the difference using the following equation:  $\Delta P = P_1 - P_2$

$\Delta P$ : ..... \_\_\_\_\_ dBm

For example:

$$\Delta P = (-12 \text{ dBm}) - (-8 \text{ dBm})$$

$$\Delta P = -4 \text{ dBm}$$

- 13 Close the Power Monitor window.
- 14 Choose Power Monitor Settings from the Service menu.
- 15 In the Power Monitor Setup dialog box, enter the following values:
  - Power constant: .....  $\Delta P$  (as calculated above)
  - Under range limit: ..... -43 dBm
  - Insertion loss reference: ..... -15 dBm
  - TLS power: ..... 0 dBm
  - TLS wavelength: ..... 1558.5 nm

- 16 Click OK.
- 17 Click the Power Monitor button on the main window. Verify that the displayed power is within  $\pm 0.5$  dB of value  $P_1$ .
- 18 Click the Set zero button from within the Power Monitor window.
- 19 Close the Power Monitor window. The TLS automatically reverts to system

**Adjusting the Power Monitor**

control.

***Adjusting the Low Band values***

Perform the following steps only if you have a dual band system.

**20** Repeat the adjustment for the low band. Set the optical power meter to 1308 nm when reading low band power. Enter the following values into the Power Monitor Setup under the 1300 nm column.

**21** Enter the following values.

Power constant: . . . . .  $\Delta P$ , as calculated above  
Under range limit: . . . . . -43 dBm  
Insertion loss reference: . . . . . -15 dBm  
TLS power: . . . . . -4 dBm  
TLS wavelength: . . . . . 1308 nm



## Setting Normalization Preferences

You can specify many of the settings used for normalizing measurements. These are the parameters the system uses when a length normalization is performed during a normalization. It measures the length of the "through" cable and stores it for later use.

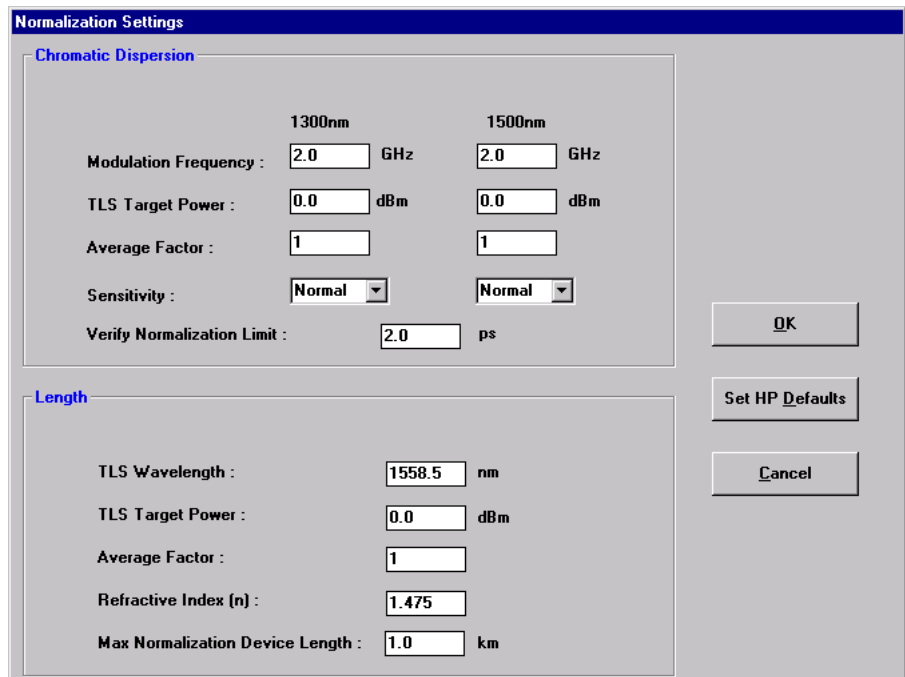
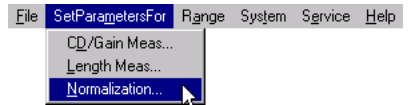

**Figure 3-3. Normalization Settings Window**

### ***Set HP Defaults***

Selects the system's default values.

## **Setting Normalization Preferences**

### ***Modulation Frequency***

RF frequencies used to modulate the optical signal in the test and reference measurement operations.

### ***TLS Target Power***

The level requested of the tunable laser source. If it cannot supply the full amount, it will supply as much as it can.

### ***Average Factor***

Controls the number of network analyzer sweeps which are averaged to measure group delay at each wavelength point. The measurement time is proportional to the average factor. Noise reduction is proportional to the square root of the average factor. Select the *Sensitivity*: Normal, High, or Highest.

### ***Sensitivity***

Determines the IF bandwidth used by the network analyzer. The settings Normal, High and Highest correspond to 300, 100 and 30 Hz, respectively. This setting affects the length of time required to complete a measurement. The higher the sensitivity, the longer the measurement time. Noise is reduced at higher sensitivity.

### ***Verify cal limit***

The group delay limit for the normalization verification. This is the limit against which the system compares the data obtained when a normalization verification is performed.

### ***TLS Target Power***

The level requested of the tunable laser source. If it cannot supply the full amount, it will supply as much as it can.

### ***Average Factor***

Controls the number of network analyzer sweeps which are averaged to measure group delay at each wavelength point. Noise is reduced by one over the square root of the averaging factor, but measurement time increases in proportion to averaging factor.

### ***Max Cal Device Length***

The maximum length for the “thru” cable. The smaller this length, the faster the length normalization. However, the time savings typically is only about 1 second. Since setting this value lower than the actual “thru” length results in an incorrect length normalization, this value should be set well above the max-

**Setting Normalization Preferences**

imum “thru” length you expect to use. For example, if the maximum "thru" length in your factory is 120 meters, enter 0.5 km to avoid potential problems with length normalization.



---

# 4

|                                 |      |
|---------------------------------|------|
| Setting up a Measurement        | 4-4  |
| Performing a Measurement        | 4-13 |
| Reading the Measurement Results | 4-16 |
| TES Parameters                  | 4-21 |
| TES Min/Max Parameters          | 4-38 |
| Output Parameters               | 4-41 |

---

## Remote Control

## Remote Control

This chapter shows you how to make chromatic dispersion measurements from a remote location. This is accomplished through a database parameter file which specifies settings such as range, step size, filename for saving results, operator's name, and the date that the measurement was made. You can even create your own graphical user interface to control the system.

---

**CAUTION**

---

Remote operation of the system should only be attempted by advanced users who have substantial Visual Basic<sup>1</sup>, networking, and Windows NT experience. *Always* create a backup of the database file before making any changes.

### ***You'll use the following tools***

- Windows NT 4.0 which is included on the system hard drive and the accompanying CD-ROM.
- Microsoft Service Pack 5
- TESServer.dll file and associated files
- Remote shell software from Denicomp Systems provided with the system. This software is required for executing a test.
- Visual Basic example source code located in C:\HPCD\REMOTE SAMPLE
- Visual Basic Professional Version 5.0 development environment. This software is useful for working with the example code and is required for interaction with the TESServer.dll file.
- Microsoft Access 97<sup>2</sup>, another database tool, or Visual Basic Professional 5.0. Use this software to access the Results.mdb database. The HP example code included with the system uses Visual Basic and SQL commands.

1. Visual Basic is a product of Microsoft Corporation.  
2. Microsoft Access 97 is a product of Microsoft Corporation.

***Making measurements requires three steps***

To perform remote measurements, you must create an application on your remote computer to perform these three steps:

- 1 “Setting up a Measurement” as explained on [page 4-4](#)
- 2 “Performing a Measurement” as described [page 4-13](#)
- 3 “Reading the Measurement Results” as described on [page 4-16](#)

[Figure 4-1](#) shows the interaction between your remote computer and the database files.

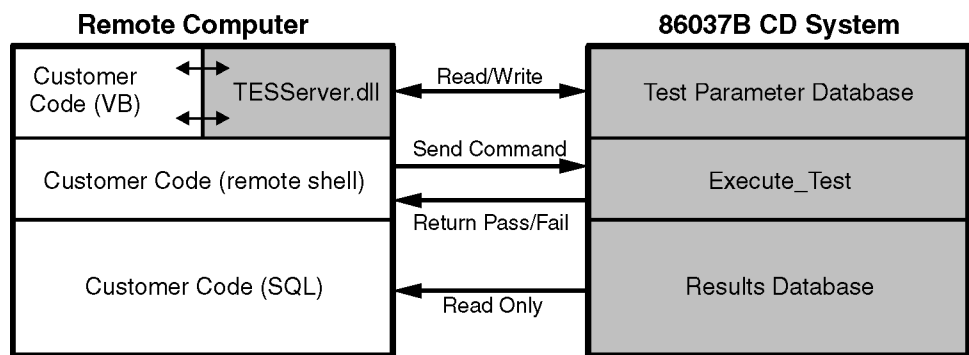

remote1.odr

**Figure 4-1. Figure 1: Overview of remote interaction**

Measurement execution on the Agilent 86037B is controlled via a test executive shell (TES) that is contained in the file TESServer.dll. Your remote application uses the TES to edit test parameters and start tests. Measurement results are retrieved independently of the test executive.

The test parameter variables that the TES uses to perform a measurement are grouped according to the internal structure of the test executive. The test executive divides measurements into four hierarchical levels, each having their own corresponding test parameters. These four levels are (in order from highest to lowest):

- System level
- Test plan level
- Test group level
- Test level

## Setting up a Measurement

To set up the measurement system, compile the interface code with the Visual Basic files and the HP supplied TESServer.dll file. The TESServer.dll file allows your software to read and write test parameters to and from the test parameter database file, testparm.mdb, without requiring knowledge of the database's underlying structure.

---

**CAUTION**

---

The test parameter database file, testparm.mdb, is a complicated structure. Damage to the file can render the Agilent 86037B unusable until the database is replaced or repaired. For this reason, direct access of the testparm.mdb database is not recommended or supported by Agilent Technologies.

Communication between the TESServer.dll on your computer and the databases on the system is via a direct network connection to the system's hard drive. You'll need to supply this network connection.

Setting up a measurement requires the following three steps:

- 1** From testparm.mdb, extract the parameter collection that will be passed to the test.
- 2** Edit the test parameter values in the collection.
- 3** Save the collection to testparm.mdb after all editing is complete.

When the measurement is executed, the collection is retrieved by the test executive from the test parameter database and used to perform the measurement.

---

## Extract the test parameters

The TESServer.dll can be installed on your remote computer in two ways. A complete set of files can be installed using the installation file on the accompanying CD-ROM. Or, you can copy the TESServer.dll file along with its companion files tes.ini, io.mdb, and security.mdb from the system C:\HPCD directory. Once



installed the dll should be registered with the MS Windows NT registry on your remote machine. This may be done by simply using a command such as “regsvr32.exe C:\HPCD\TESServer.dll”.

The tes.ini file determines the initial settings for the TESServer.dll. This file is used to set the default locations of the four databases required by the TESServer.dll on start-up. None of the other items in the tes.ini file should be changed. Typically, the path of the io and security databases are left at the C:\HPCD directory of the remote machine while the location of the test parameter and results databases are set to the location of the Agilent 86037B system that is to be controlled.

#### **Example tes.ini file**

Notice that testparm.mdb and results.mbd are located on the drive F (redirected via the LAN).

```
[Reporting]
NonDefault=False
[TestLog]
LogToFileEnabled=False
LogToScreenEnabled=True
MsgLines=100
[OperatorPrompt]
AutoResponseEnabled=False
PromptDuration=0
[SplashScreen]
NonDefault=False
Filename=
[PathNames]
TestParms=F:\HPCD\CUSTOMER
IOConfig=C:\HPCD
Security=C:\HPCD
Results=F:\HPCD\CUSTOMER
TestLog=F:\HPCD\CUSTOMER
[Station]
;StationID=Customer_Low_Band
StationID=Customer_Dual_Band
;StationID=Customer_Dual_Band
;StationID=Pre Test
[Version]
VersionNo=A.07.27
```

**Setting up a Measurement**

When the test parameter editor is started, the first action is to login to the TESServer.dll:

```
'First create an instance of the TESManager
Set TESMgr = New TESManager

'Open the TESManager session
TESMgr.OpenSession
```

If the TESServer.dll is not found, check that it is registered under the “project\references” menu in the Visual Basic IDE. Once located, the user must log in with a user ID appropriate for editing the test parameter database as shown below:

```
'Hardcoded userID and password for editing test parameters:
TESMgr.Controller.ShellConfig.sCommandOpts = "-userid editor -passwd parm"
```

This starts the TESServer in a mode useful for editing the test parameters of the Testparm.mdb database. The database may be located anywhere on the network as long as its location is shown by the path in the tes.ini file. Once the user is logged into the TESServer.dll the test parameters may be edited. Typically the parameters are not dealt with individually. The test parameters are returned as a collection of variables, one collection for each level in the test executive.

The following “Example for obtaining collections for a given test group” on page 4-7 has the main statement:

```
m_oController.LoadParms "", "", "", ""
```

In order for this statement to succeed, the following lines first build a collection of the particular tests of interest in the test group of interest:

```
Set m_colTestsToRun = Nothing
Set m_colTestsToRun = New Collection
add_test "Test_Gain_Phase"
add_test "Test_Length"
```

In essence, add\_test reads information about the test from the parameter database and places several pieces of that information in a structure that is included in the “m\_colTestsToRun” collection. The LoadParms method then causes several parameter collections to be populated: the collection of system level parameters, the test plan level parameters, the test group level parameters as well as the parameter collections for the individual tests. The first three levels of parameter collections are standard Visual Basic collections and the individual parameters may be accessed as described below. The parameter collections at the test level are not Visual Basic collections, but are TEScollections. These are much like Visual Basic collections but are within a wrapper

that handles some error conditions more gracefully than VB collections. TEScollections are close enough to Visual Basic collections that the items within the TEScollection can be accessed as described in “Edit the test parameters” on page 4-11.

**Example for obtaining collections for a given test group**

```
'This line returns the active system, i.e. Agilent 86037B
m_sActiveSystem = m_oController.ActiveSystem
'This line sets the active test plan, always "Standard_Test_Plan"
m_sActiveTestPlan = "Standard_Test_Plan"

'These 2 lines clear the collection
Set m_colTestsToRun = Nothing
Set m_colTestsToRun = New Collection

'These 2 lines add the TES Tests to be edited to the collection
add_test "Test_Gain_Phase"
add_test "Test_Length"

'This sets the Test Group for the 'variables to be edited
m_sActiveTestGroup = "Start_Test"

'The complete code for this subroutine 'is given below
setup_testplan

'This obtains the test parameters from 'testparm.mdb
m_oController.LoadParms "", "", "", ""

'The first three collections are Visual Basic collection objects
Set colCDSsystemParms = m_oController.m_colSystemParms
Set colTestPlanParms = m_oController.m_colTestPlanParms
Set colStartTestGroupParms = m_oController.m_colTestGroupParms
'This is a TEScollection or a collection of collections.
Set colTestParms = m_oController.m_oTestParms

Set TEScolTestGainPhaseParms = colTestParms("Test_Gain_Phase")
```

Once the tests and test group have been setup, the collection is built with the setup\_testplan subroutine.

The final step in obtaining the parameter collections is to set a local collection equal to the TES System parameter collection, the Test Plan parameter collection, and the Test Group collection to set TEScollections equal to the individual item collections in the Test level TEScollection of TEScollections. That last assignment is illustrated by the following statement:

```
Set TEScolTestGainPhaseParms = colTestParms("Test_Gain_Phase")
```

There is one such member for each Test in the collection of Tests to be run.

**Setting up a Measurement****The add\_test subroutine**

```

Public Sub add_test(str, Optional bReport = False)
'
' Purpose: Adds the test name to the collection of tests to be run.
' Used when getting TES parameter collections.
'
Dim sTestName As Variant
Dim rsTestTable As Recordset
Dim oTest As TestObjDataType
With TESMgr.ParmMgr
    sTestName = str
    If .GetTestRecord(sTestName, rsTestTable, True) Then
        Set oTest = New TestObjDataType
        oTest.sTestName = rsTestTable!sTestName
        oTest.lTestID = rsTestTable!lTestID
        oTest.sReference = rsTestTable!sReference
        oTest.iIndex = 1
    oTest.bTestEnabled = True
    oTest.bReportEnabled = bReport
    oTest.sDescription = rsTestTable!sDescription
    m_colTestsToRun.Add Item:=oTest, Key:=oTest.sTestName
    Set oTest = Nothing
    End If
    If m_colTestsToRun.count > 0 Then
        .GetTestSeqOptions m_sActiveTestPlan, m_sActiveTestGroup, _
            m_colTestsToRun
    End If
End With
End Sub

```

**The setup\_testplan subroutine**

```

Private Sub setup_testplan()
'
' Purpose: Tells the test executive (TES) the active test plan and group.
' used in connection with extracting parameter collections
' and executing test plans.
'
With TESMgr.Controller' The following lines refer back to the TES Manager object
    .ActiveTestPlan = m_sActiveTestPlan
    .ActiveTestGroup = m_sActiveTestGroup
    Set .TestsToRun = m_colTestsToRun
    .SerialNumber = ""
    .TestPlanNotes = ""
    Set .Devices = TESMgr.InstMgr.Devices
End With
End Sub

```

Note that it is also possible for the user to access the collections for the System, Test Plan, or Test Group levels individually. In this case one of the following methods can be used:

```
TESMgr.ParmMgr.LoadSystemParms colSystemParms, ""  
TESMgr.ParmMgr.LoadTestPlanParms colTestPlanParms, ""  
TESMgr.ParmMgr.LoadTestGroupParms colTestGroupParms, ""
```

Each of the above methods return just the one collection, whereas the expression used previously,

```
TESMgr.Controller.LoadParms "", "", "", ""
```

loads all levels of the parameter collections.

There are some limitations with using these more primitive statements. First the test executive supports scoping of parameters. That is, if a parameter occurs at the Test Group level with one value and at the Test level with another value, you need to use the value from the lower level (for example, the second value) when running the test. If the variable is missing from the Test Group level then you need to use the value from the Test Plan level. The other limitation is that the parameter collections at the Test level are expected to be TEScollections and the result of the LoadTestParms is a Visual Basic collection. The example file illustrates the procedure for obtaining the collections individually, but once obtained, any changes are saved as a single group.

The above code requires knowledge of the test parameter names in the testparm.mdb database. These test parameters are the same as the information displayed and entered in the system GUI. The testparm.mdb database contains all of the setup information required in the execution of the individual tests. All of the constants required by the GUI for parameter checking are also included in this database. Each parameter is located in a single location in the database. The location depends upon the type of parameter and how it is utilized in the system software. Full information including the definition of the parameter in the database that is associated with each field in the GUI and documentation of the location of the parameter is supplied in "TES Parameters" on page 4-21.

In order to correctly deal with the parameter scoping described above, the complete test plan hierarchy is shown "Complete test plan hierarchy" on page 4-10. The hierarchy names defined must be used exactly as shown in order to manipulate data within the testparm.mdb database.

**Setting up a Measurement**

**Complete test plan hierarchy**

Systems:

- Customer\_Dual\_Band
- Customer\_High\_Band
- Customer\_Low\_Band

Test Plans:

- Standard\_Test\_Plan

Groups & Tests:

- Initialize
  - Read\_TLS\_Specs
- Start\_Test
  - Test\_Connect
  - Test\_Length
  - Test\_Gain\_Phase
  - Test\_CD
  - Add\_Run\_Number
- Modulator\_Bias
  - Mod\_Bias\_Connect
  - Mod\_Bias\_Adjust\_LB
  - Mod\_Bias\_Adjust\_HB
- New\_Calibration
  - Cal\_Connect
  - Mod\_Bias\_Adjust\_LB
  - Mod\_Bias\_Adjust\_HB
  - Cal\_Length
  - Cal\_Gain\_Phase
  - Cal\_Processing
  - Add\_Run\_Number
- Verify\_Calibration
  - Verify\_Connect
  - Mod\_Bias\_Adjust\_LB
  - Mod\_Bias\_Adjust\_HB
  - Cal\_Gain\_Phase
  - Verify\_CD
  - Verify\_Processing
- Power\_Monitor
  - PM\_Connect
  - Power\_Monitor
- Select\_TLS
  - Select\_TLS

---

## Edit the test parameters

This section describes the editing of individual collection parameters. As an example of a collection, consider colParms which is a collection of parameter objects, one for each parameter accessed in an example test. The parameter objects are collections of variables containing information about an individual parameter. They contain no methods. The data items might be:

```
Public Filter As Boolean
Public Operator As String
Public Start_Wavelength As Variant
Public Stop_Wavelength As Variant
Public Use_Ref_Wavelength As Boolean
Public Use_Wavemeter As Boolean
Public Test_Groups As Integer
Public Tests_Per_Group As Integer
Etc.
```

Each of these items is the contents of one of the fields in the Test Parameter database for one of the parameters. Scalar items are accessed by using an expression of the form,

```
colParms.item("Start_Wavelength").vValue
```

where the crucial part is a string whose value is the name of the parameter. The above expression can be used on the right hand side of an assignment expression to obtain the current value of the parameter attribute. This expression appearing on the left hand side of an assignment changes the attribute.

Accessing an item that is an array of values is done somewhat differently. The rule to note is that you must fetch the whole array parameter first and then get the nth element of that array. For example:

```
Private m_colParms As Variant
Private m_vCalWavelengths As Variant
Private m_dOneOfTheWavelengths as Double

m_colParms = colParms
m_vCalWavelengths = m_colParms.item("Cal_Wavelength").vValue
m_dOneOfTheCalWavelengths = m_vCalWavelengths(14)
```

---

## Save the test parameters

When editing is complete, any changes need to be written to the parameter database. The subroutine `StoreLevelParms` requires that the first parameter be a collection and the second be an integer corresponding to the level in the test plan hierarchy. Since the parameter collection for the Test level is a `TESCollection`, rather than a standard Visual Basic collection, you must apply the “Items” method or use the method: `TESMngr.ParmMngr.LoadTestParms` as done in the example file in order to extract the underlying collection from within the `TESCollection`.

**Table 4-1. Integer Parameter Definitions for StoreLevelParms**

| Test Plan Hierarchy Level | Integer |
|---------------------------|---------|
| System level              | 3       |
| Test Plan                 | 2       |
| Test Group                | 1       |
| Test level                | 0       |

### Example code for writing database parameters

```
Public Sub save_parm_values()
    ' Purpose: Returns parameters to the database.

    With TESSMgr.ParmMngr
        With TESSMgr.Controller
            .ActiveTestPlan = sActiveTestPlan
            .ActiveTestGroup = sActiveTestGroup
        End With
        .StoreLevelParms colSystemParms, 3
        .StoreLevelParms colTestPlanParms, 2
        .StoreLevelParms colTestGroupParms, 1
        .StoreLevelParms colTestParms, 0
    End With
End Sub
```



---

## Performing a Measurement

Commands to execute, stop, and abort a measurement are issued via a remote shell software interface through the network. The commands are sent to the test executive of the system that executes them. In addition to sending the commands, your software can also receive the pass/fail result of a measurement from the system.

When it comes to the actual performance of the tests by an operator at a computer different from the system computer, a remote execution package is invoked which communicates with a custom component of the test executive. The test executive is initiated on the Agilent 86037B from the remote computer via a version of remote shell service supported in MS Windows NT 4.0. This remote shell service software is the supplied Denicomp Systems software.

Successful remote execution of the system includes the following steps:

- 1** Setup and initiation of the remote shell services software on the remote computer.  
  
This can be done using user-supplied remote shell software or, if the remote computer is a Windows NT 4.0 system, using the software located in the C:\HPCD\RELATED INSTALLATIONS\RSH directory.
- 2** Setup and initiation of the remote shell services software on the Agilent 86037B. To install this software (a product of Denicomp Systems), follow the instructions provided in the supplied software package.
- 3** Initiation of part of the test executive called MsgCenter on the Agilent 86037B.
- 4** Initiation of the execution of a test plan, a test group, or a test.
- 5** Issuance of any cancel or abort commands, as necessary.
- 6** Display of the pass or fail results.
- 7** Termination of the MsgCenter on the Agilent 86037B.

Before starting the remote shells, the .rhosts files should be setup. The .rhosts file on the measurement computer should contain the IP address and user name of the remote computer while the remote computer should have the IP

**Performing a Measurement**

address and user name of the measurement computer. Once the remote shell service has been successfully started and the correct .rhosts files exist on both the remote machine and the measurement computer, the message client and server may communicate.

Initiation of the MsgCenter part of the test executive on the measurement computer is accomplished by issuing the “rsh” command on the remote computer along with the name of the test program and the appropriate UserID and password. Note, the rsh.exe file is normally installed in the “system32 directory during the installation of networking under Windows NT 4.0. More information on rsh commands may be obtained from the MS Windows NT documentation. The correct syntax is in the example file and is shown below:

```
"rsh.exe " & remote_machine & " -l " & login_name & " c:\hpcd\cd_shell.exe " & "-userid " & userid & " -passwd " & passwd & " -quiet -host " & local_machine & " -port " & PORT
```

The correct user ID and password to use for remote operation of the measurement computer are remote\_user and HPCD respectively, as shown in the example file.

The communication package, MsgCenter, in the test executive control program is called a “server” in TCP/IP terms because the socket is started in Listen Mode awaiting a message from a Client, in our case the user software running on the remote machine. Since the development of the remote test control program is the responsibility of the user, HP provides only a simple example control program that demonstrates the use of the communication function to connect to MsgCenter, start a given test, abort a running test, and close MsgCenter.

The Message Server and the Message Client communicate over socket 4444. All messages between the two programs, the client and server, are variable length character strings. The first six characters of these messages contain the total length of the message. The maximum length of a single transmission is currently set at 8096 bytes. A message can involve multiple transmissions.

The control program on the remote machine can send the following fixed messages:

```
"000015@@@ABORT@@"
"000016@@@CANCEL@@"
"000014@@@STOP@@"
```

The ‘@’ is used to avoid confusion with other messages between the programs. The other messages from the remote control program to the system specify the running of specific tests. These have the following format:

Six characters containing the total length followed by “testplan:” followed by test\_plan\_name.

or

Six characters containing the total length followed by “testgroup:” followed by test\_group\_name.

### ***Message Server***

The Message Server within the Agilent 86037B is automatically invoked by the login to the test executive. After opening a window titled MsgCenter, its initial action is to connect to socket 4444. When the connection is completed the Message Server then awaits a read event on the socket.

When messages from the remote control program arrive at the Message Server they are interpreted and appropriate action is taken.

In response to a STOP message, the logout function in the test executive is called and the Message Server is shut down. Similarly, when a CANCEL or ABORT message arrives, the appropriate test parameter variables are set within the test executive.

When messages for running a test are received, built-in functions for creating the list of tests to be performed are called, followed by the creation of the test parameter collections and finally, the function to actually execute the test. Following the execution of a test, the Message Server will await the reception of another message.

### ***Message Client***

The message client on the remote machine may be any software that correctly sends the above commands via socket 4444 to the message server on the Agilent 86037B.

## Reading the Measurement Results

You can read results database, `results.mdb`, directly by using a variety of techniques. The approach documented here uses SQL commands implemented in a Visual Basic example program. As in the test parameter database, communication is via a network connection to the system hard drive.

You can use another database tool, such as MS Access 97, to access the test results. Note that all access should be *read-only* thus eliminating the possibility of database corruption and possible loss of data.

The one unusual aspect of the `results.mdb` database is the storage of arrays. The structure of the `results.mdb` database can be investigated with the Visual Data Manager add-in included in Visual Basic 5.0 Professional or any other database tool, such as MS Access 97. The database consists of three tables. The relationship between the tables is shown in [Figure 4-2](#).

The leftmost table, `DUTInfo`, contains one row for each test run. For each row in `DUTInfo`, there is a set of rows in the `TestInfo`, each of which contains information about the tests which were executed during the run. A record set of rows from the `TestInfo` table for a given run is created by specifying in the WHERE clause of the SQL statement, `!ReportID`. For each row in `TestInfo`, there is a set of rows in the `Parameter` table, each of which contains information about each variable stored in that test. A record set of rows from the `Parameter` table for a given run and test is created by specifying in the WHERE clause of the SQL statement, `!ReportID` and `!TestID`. The `ReportID` is directly related to the run number of the measurement while the `TestID` identifies the test group. More details are given in the example file and below.

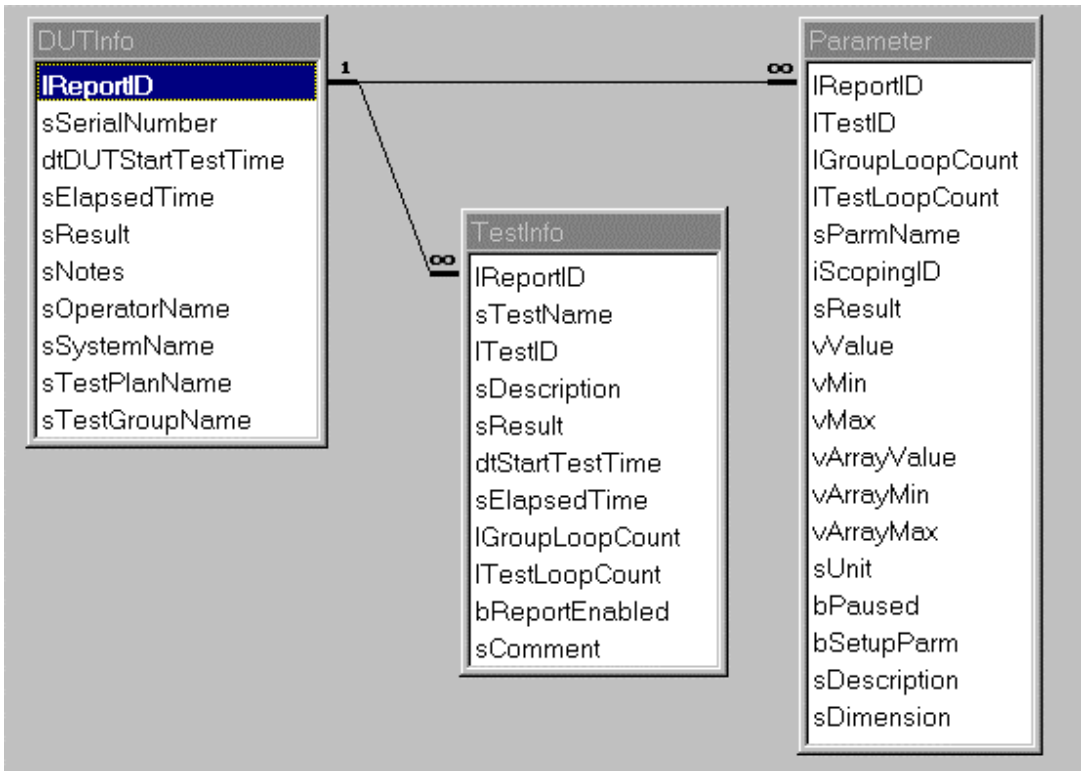

**Figure 4-2. Relationship between the three tables of the results.mdb database.**

First, open the results database with the following lines of code:

```
Private m_dbResults As Database
dbPath = txtDBPath & "Results.mdb"
' Open the results database
Set m_dbResults = OpenDatabase(dbPath, False, True) ' Open database as shared, read-only
```

The results database has three linked tables, DUTInfo, TestInfo, and Parameter. The simplest way to handle the linkage is to create a sequence of recordsets. The first might be accessed with something like:

```
sql_command = "SELECT * FROM DUTInfo WHERE sTestGroupName = 'New_Calibration' " & "AND sResult = 'PASSED' ORDER BY IReportID DESC;"
Set rsReportID = dbResults.OpenRecordset(sql_command, dbOpenDynaset)
```

**Reading the Measurement Results**

where rsReportID will contain all of the rows of the first table DUTInfo which contain information about all of the runs where the Test Group name is “New\_Calibration” and the test result is “PASSED”. Looping through all the members of the recordset one then extracts all of the TestIDs related to those members.

```
With rsReportID
  While Not .EOF
    sql_command = "SELECT ITestID FROM TestInfo WHERE IReportID = " & !IReportID & _
                  " AND sTestName = 'Cal_Gain_Phase'
    ORDER BY ITestID;"
    Set rsTestID_gain_phase = dbResults.OpenRecordset(sql_command, dbOpenDynaset)

    While Not rsTestID_gain_phase.EOF
      sql_command = "SELECT * FROM
Parameter WHERE IReportID = " & _
                  !IReportID & " AND ITestID = " &
rsTestID_gain_phase
                  !ITestID_cal_gain_phase
    Set rsParam_cal_gain_phase =
      dbResults.OpenRecordset(sql_command, dbOpenDynaset)
```

This code results in a recordset containing all the rows of the table containing data related to the “Cal\_Gain\_Phase” test in a run of the “New\_Calibration” test group which passed. (Data from other such successful tests can be found by looping through the rsReportID recordset.) Now that the desired information is in a recordset, an individual datum can be retrieved.

```
range = GetParm(rsParam_cal_processing, "Range")
```

The code above gets the value of the variable “range” from the first (and only) row of the recordset rsParam\_cal\_gain\_phase that contains the result data for “range”.

### The GetParm subroutine

The routine GetParm is given by the following:

```
Public Function GetParm(rsData As Recordset, sParmName As String) As Variant
' Caution: All non-array values are returned as strings. Thus if you are
' getting a number, it may be necessary for you to use Val(GetParm())
' so that the parameter is converted to a number.
Dim btByteArray() As Byte

With rsData
If Not .BOF Then
.FindFirst "sParmName = '" & sParmName & "'"
If Not .NoMatch Then
If !vValue <> "<ARRAY>" Then
GetParm = !vValue
Else
btByteArray = !vArrayValue.GetChunk(0, vArrayValue.FieldSize())
GetParm = ByteArrayToVariant(btByteArray)
End If
Else
Err.Raise vbObjectError, "GetParm", sParmName & _
" parameter undefined in results database!"
End If
Else
Err.Raise vbObjectError, "GetParm", sParmName & _
" parameter undefined in results database!"
End If
End With
End Function
```

The GetParm subroutine finds the first row in the recordset that contains the desired parameter name and returns its value. Note the use of the Visual Basic GetChunk method and the ByteArrayToVariant routine. This is the technique used to store array values in the results database. The database treats the long binary as a binary large object (or “BLOB”) and in order to obtain the actual array values, the BLOB must be converted. The ByteArrayToVariant function uses file I/O to convert between data stored as a long binary and a Visual Basic variant array.

**Reading the Measurement Results****The ByteArrayToVariant subroutine**

```

Private Function ByteArrayToVariant(ByRef btByteArray() As Byte) As Variant
'
' Purpose: The data has
' to be assigned to variable length byte array first, and then converted
' to variant via binary file operation.
'
Dim sTempFilename As String
Dim iTempFileNum As Integer
Dim avParm As Variant
'
iTempFileNum = FreeFile
sTempFilename = App.Path & "\TEMP.BIN"
'
If dir(sTempFilename) <> "" Then Kill sTempFilename
Open sTempFilename For Binary As #iTempFileNum
Put #iTempFileNum, , btByteArray
Get #iTempFileNum, 1, avParm
Close #iTempFileNum
Kill sTempFilename
'
ByteArrayToVariant = avParm
'
End Function

```

In order to extract a single value from the results database it is necessary to know the name of the value. These names are listed in “Output Parameters” on page 4-41.

Typically, the user is interested in the results of a run or measurement. This data is located by first finding the appropriate ReportID number corresponding to the desired run number, as demonstrated in the example code. Once the ReportID number is known, the final results data, as seen on the data review screen of the system GUI, is found in the Test\_CD section of the database that has the TestID number 15. Since it may be useful to look at the raw data, uncorrected for calibration, this is found in the Test\_Gain\_Phase section that has the TestID number 42. In addition to the final results of a measurement, all of the pertinent parameters used to generate that result are also stored in the results.mdb database.



---

## TES Parameters

The tables below define the TES parameter in the database associated with each item in the GUI. The table also defines where in the database hierarchy the parameter is located.

The table defines parameters for a high band system. Parameters with the “\_HB” at the end are parameters that depend upon the type of Agilent 86037B Chromatic Dispersion Test System (1300, 1500, or DUAL). For a Low Band system, the “\_HB” will be replaced with “\_LB”. A Dual Band system will have two parameters, one with the “\_LB” extension and one with the “\_HB” extension.”

The “Delta” field in the Wavelength Selection area of the Main GUI is not used by any test and therefore is not located in the database.

The Step Wavelength field in the Calibration GUI is not used by any test and therefore is not located in the database.

Table 4-4, “System Preferences Dialog Box,” on page 4-27

Table 4-5, “CD and Gain Measurement Settings Dialog Box,” on page 4-29

Table 4-6, “Length Measurement Settings Dialog Box,” on page 4-31

Table 4-7, “Calibration Settings Dialog Box,” on page 4-33

Table 4-8, “New Normalization Button Dialog Box,” on page 4-35

Table 4-9, “Power Monitor Setup Dialog Box,” on page 4-36

Table 4-10, “Various System Parameters,” on page 4-37

## Main chromatic dispersion screen

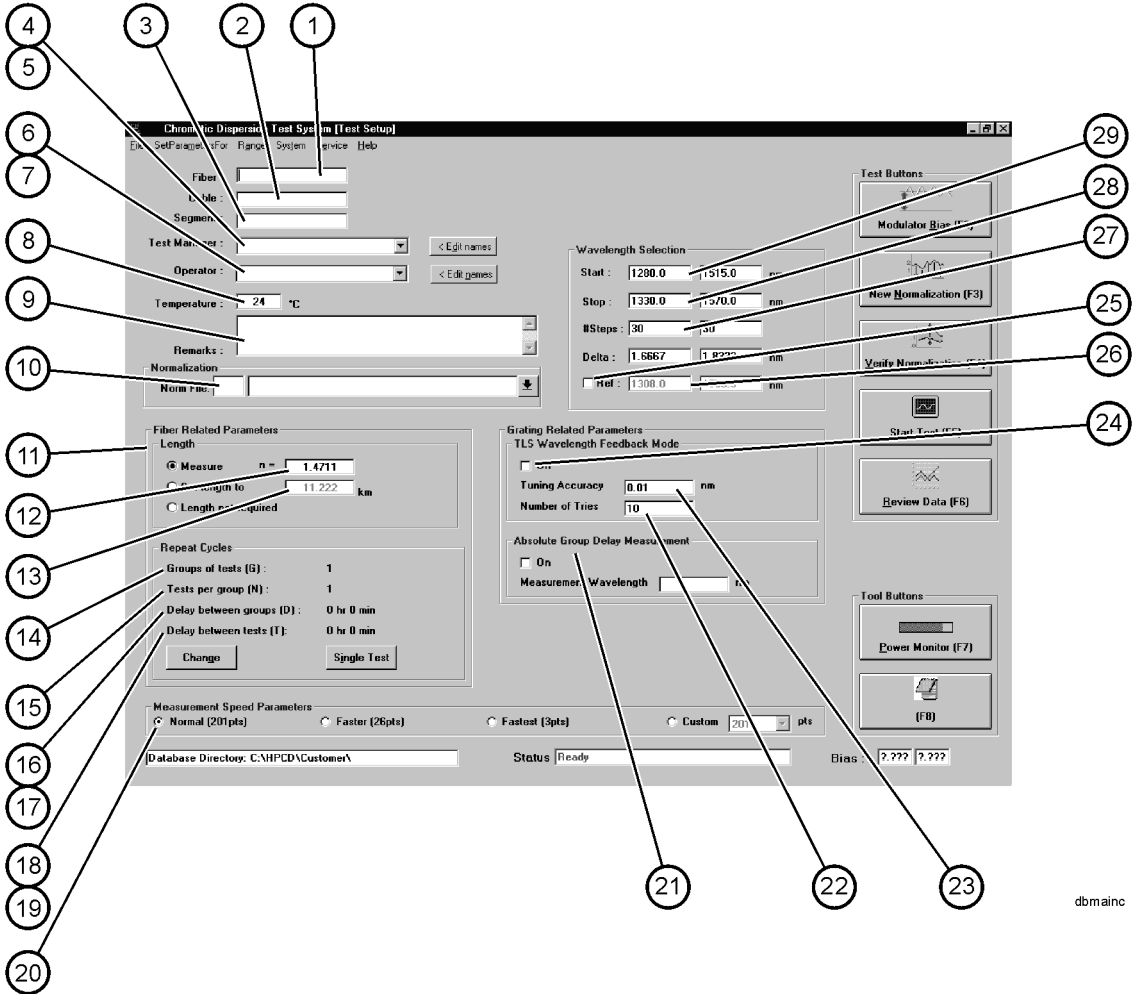

dbmainc

**Table 4-2. Main Chromatic Dispersion Screen (1 of 3)**

| Item | TES Name          | Parameter Location in Database             | Data Type           | Comments  |
|------|-------------------|--|---------------------|---|
| 1    | Device_Name_1     | System                                     | String              |   |
| 2    | Device_Name_2     | System                                     | String              |   |
| 3    | Device_Name_3     | System                                     | String              |   |
| 4    | Test_Manager_List | System                                     | String Array (0:99) | Selected item will be put in Test_Manager TES parameter.  |
| 5    | Test_Manager      | System                                     | String              | Item selected by operator from Test_Manager_List  |
| 6    | Operator_List     | System                                     | String Array (0:99) | Selected item will be put in Operator TES parameter.  |
| 7    | Operator          | System                                     | String Array        | Item selected by operator from Operator_List  |
| 8    | Temperature       | System                                     | Single              |   |
| 9    | Remarks           | System                                     | String              |   |
| 10   | Cal_File          | System                                     | Integer             |   |
| 11   | Length_State      | Group: Start_Test<br>Test: Test_Length     | Integer             | Radio buttons selected by operator in the Length". Determines whether to do length test. 0 = Measure. 1 = Set length to. 2 = Length not required. Set to 0 at software startup.   |
| 12   | Refractive_Index  | System                                     | Double              |   |
| 13   | Set_Length        | Group: Start_Test<br>Test: Test_Length     | Double              |   |
| 14   | Test_Groups       | Group: Start_Test<br>Test: Test_Gain_Phase | Integer             | This parameter can be modified in two ways:<br>1. Pressing the Change" button brings up the Repeat Measurement Selector GUI. The entry in the How many groups of tests (G)?" field controls this parameter. 2. Pressing the Single Test" button sets this parameter to 1. |

Remote Control  
**TES Parameters**

**Table 4-2. Main Chromatic Dispersion Screen (2 of 3)**

| <b>Item</b> | <b>TES Name</b>  | <b>Parameter Location in Database</b>      | <b>Data Type</b> | <b>Comments</b>  |
|-------------|------------------|--|------------------|--|
| 15          | Tests_Per_Group  | Group: Start_Test<br>Test: Test_Gain_Phase | Integer          | This parameter can be modified in two ways:<br>1. Pressing the Change” button brings up the Repeat Measurement Selector GUI. The entry in the How many tests per group (N)?” field controls this parameter. 2. Pressing the Single Test” button sets this parameter to 1.              |
| 16          | Group_Delay_Hrs  | Group: Start_Test<br>Test: Test_Gain_Phase | Integer          | Hours number that appears next to Delay between groups:” in the Repeat Cycles”. This parameter is modified in the Repeat Measurement Selector GUI by the hours entry in the What is the delay between groups (D)” field. Pressing the Single Test” button sets this parameter to 0.    |
| 17          | Group_Delay_Mins | Group: Start_Test<br>Test: Test_Gain_Phase | Integer          | Minutes number that appears next to Delay between groups” in the Repeat Cycles”. This parameter is modified in the Repeat Measurement Selector GUI by the minutes entry in the What is the delay between groups (D)” field. Pressing the Single Test” button sets this parameter to 0. |
| 18          | Test_Delay_Hrs   | Group: Start_Test<br>Test: Test_Gain_Phase | Integer          | Hours number that appears next to Delay between tests:” in the Repeat Cycles”. This parameter is modified in the Repeat Measurement Selector GUI by the hours entry in the What is the delay between tests (T)” field. Pressing the Single Test” button sets this parameter to 0.      |
| 19          | Test_Delay_Mins  | Group: Start_Test Test:<br>Test_Gain_Phase | Integer          | Minutes number that appears next to Delay between tests” in the Repeat Cycles”. This parameter is modified in the Repeat Measurement Selector GUI by the minutes entry in the What is the delay between tests (T)” field. Pressing the Single Test” button sets this parameter to 0.   |
| 20          | VNA_NumPoints    | Group: Start_Test<br>Test: Test_Gain_Phase | Integer          |  |

**Table 4-2. Main Chromatic Dispersion Screen (3 of 3)**

| <b>Item</b> | <b>TES Name</b>     | <b>Parameter Location in Database</b>      | <b>Data Type</b> | <b>Comments</b>  |
|-------------|---------------------|--|------------------|--|
| 21          | Filter              | System                                     | Boolean          | Selected by operator in Enabled" checkbox in the Filter Measurement". True = Filter measurement selected. False = Filter measurement not selected. |
| 22          | TuningAttempts      | System                                     | Integer          |  |
| 23          | TuningAccuracy      | System                                     | Double           |  |
| 24          | Enhanced            | System                                     | Boolean          | True = Enhanced TLS mode selected. False = Enhanced TLS mode not selected  |
| 25          | Use_Ref_Wavelength  | Group: Start Test<br>Test: Test_Gain_Phase | Boolean          | True = Ref wavelength used. False = Ref wavelength not used  |
| 26          | Ref_Wavelength_HB   | Group: Start Test<br>Test: Test_Gain_Phase | Single           |  |
| 27          | Number_Steps_HB     | Group: Start Test<br>Test: Test_Gain_Phase | Integer          |  |
| 28          | Stop_Wavelength_HB  | Group: Start_Test<br>Test: Test_Gain_Phase | Single           |  |
| 29          | Start_Wavelength_HB | Group: Start_Test<br>Test: Test_Gain_Phase | Single           |  |

## Menu Bar Selections

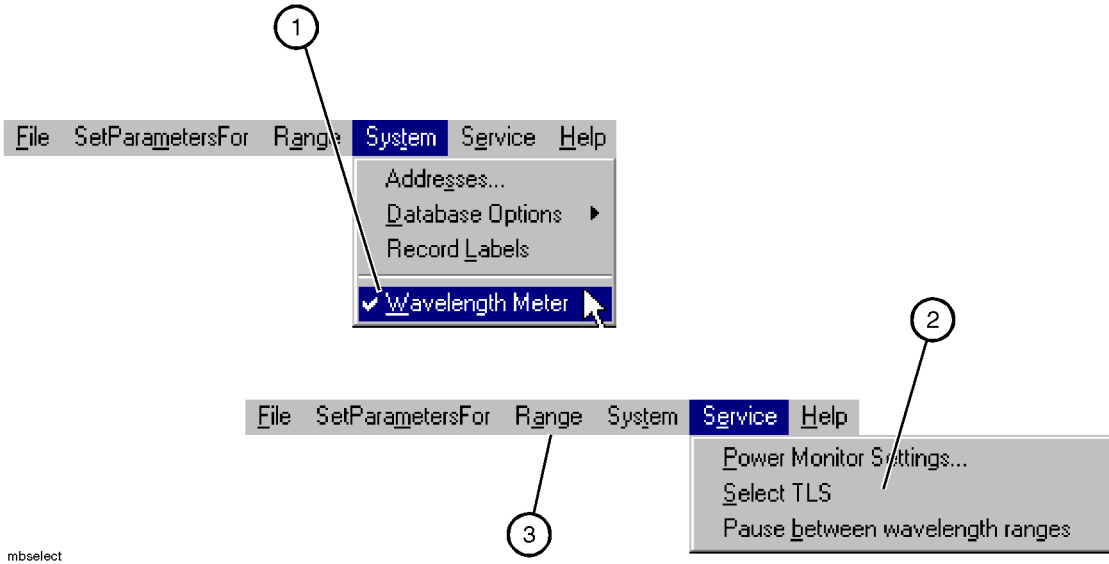

**Table 4-3. Menu Bar Selections**

| Item | TES Name                                     | Parameter Location in Database             | Data Type | Comments  |
|------|--|--|-----------|---|
| 1    | Use_Wavemeter                                | System:                                    | Boolean   | The item Wavemeter" is checked or unchecked. True = item checked (measure wavelength with wavelength meter). False = item unchecked   |
| 2    | Pause_Measurement<br>(Dual band system only) | Group: Start_test<br>Test: Test_Gain_Phase | Boolean   | The item Pause between wavelength ranges" is checked or unchecked. True = item checked (Pause between ranges). False - item unchecked |
| 3    | Range<br>(Dual band system only)             | System                                     | String    | 1300 = LOW. 1500 = HIGH. Both = DUAL  |

## System Record Labels Dialog Box

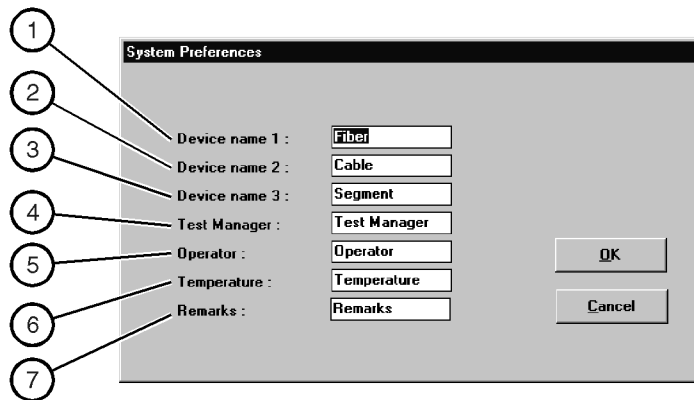

syspref

**Table 4-4. System Preferences Dialog Box**

| Item | TES Name | Parameter Location in Database | Data Type | Comments     |
|------|----------|--------------------------------|-----------|--------------|
| 1    | Title_1  | System                         | String    | Fiber        |
| 2    | Title_2  | System                         | String    | Cable        |
| 3    | Title_3  | System                         | String    | Segment      |
| 4    | Title_4  | System                         | String    | Test Manager |
| 5    | Title_5  | System                         | String    | Operator     |
| 6    | Title_6  | System                         | String    | Temperature  |
| 7    | Title_7  | System                         | String    | Remarks      |

---

## CD and Gain Measurement Settings Dialog Box

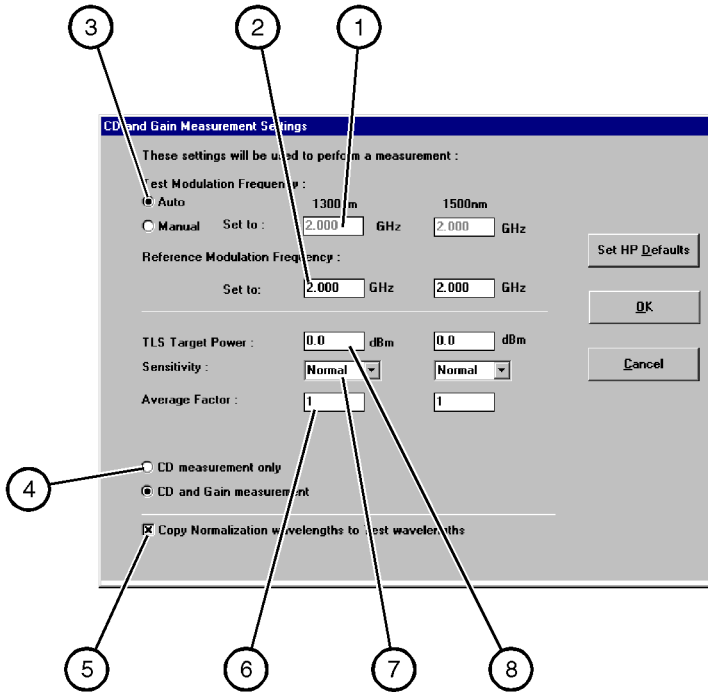

cdgain

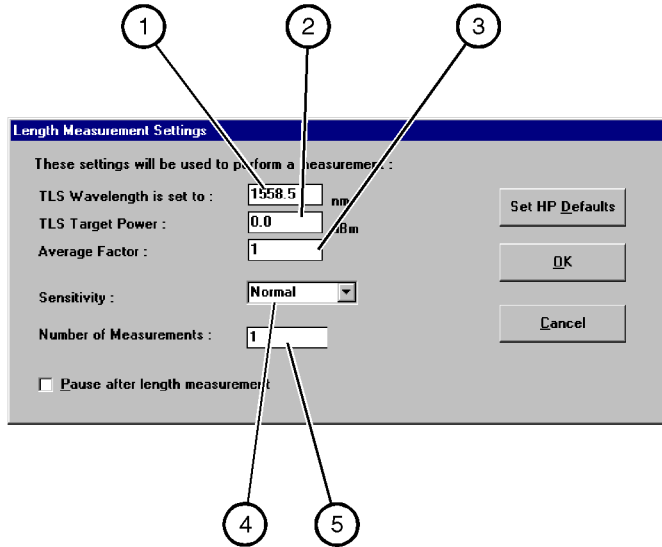

**Table 4-5. CD and Gain Measurement Settings Dialog Box**

| Item | TES Name              | Parameter Location                         | Type    | Comments   |
|------|-----------------------|--|---------|--|
| 1    | Test_Mod_Frequency_HB | Group: Start_Test<br>Test: Test_Gain_Phase | Single  |  |
| 2    | Ref_Mod_Frequency_HB  | Group: Start_Test<br>Test: Test_Gain_Phase | Single  |  |
| 3    | Auto_Mod_Freq         | Group: Start_Test<br>Test: Test_Gain_Phase | Boolean | True = Auto selected. False = Manual selected  |
| 4    | Do_Gain               | Group: Start_Test<br>Test: Test_Gain_Phase | Boolean | True = "CD and Gain measurement" selected. False = "CD measurement only" selected.   |
| 5    | Copy_Cal_WL           | System:                                    | Boolean | True = Copy Cal wavelengths. False = Do not copy Cal wavelengths   |
| 6    | VNA_AverageFactor_HB  | Group: Start_Test<br>Test: Test_Gain_Phase | Integer |  |
| 7    | VNA_IFBandwidth_HB    | Group: Start_Test<br>Test: Test_Gain_Phase | Integer | This parameter is "Sensitivity" on the GUI, but the tests need an IF bandwidth. The IF bandwidth number is stored in the database. Normal = 300. High = 100. Highest = 30. |
| 8    | TLS_PowerLevel_HB     | Group: Start_Test<br>Test: Test_Gain_Phase | Single  |  |

---

## Length Measurement Settings Dialog Box



measset

**Table 4-6. Length Measurement Settings Dialog Box**

| <b>Item</b> | <b>TES Name</b>            | <b>Parameter Location</b>              | <b>Type</b> | <b>Comments</b>   |
|-------------|----------------------------|--|-------------|---|
| 1           | TLS_Wavelength             | Group: Start_Test<br>Test: Test_Length | Single      |   |
| 2           | TLS_PowerLevel             | Group: Start_Test<br>Test: Test_Length | Single      |   |
| 3           | VNA_AverageFactor          | Group: Start_Test<br>Test: Test_Length | Integer     |   |
| 4           | VNA_IFBandwidth            | Group: Start_Test<br>Test: Test_Length | Integer     | This parameter is "Sensitivity" on the GUI, but the tests need an IF bandwidth. The IF bandwidth number is stored in the database. Normal = 300. High = 100. Highest = 30 |
| 5           | NumberOfLengthMeasurements | Group: Start_Test<br>Test: Test_Length | Integer     |   |

---

## Normalization Settings Dialog Box

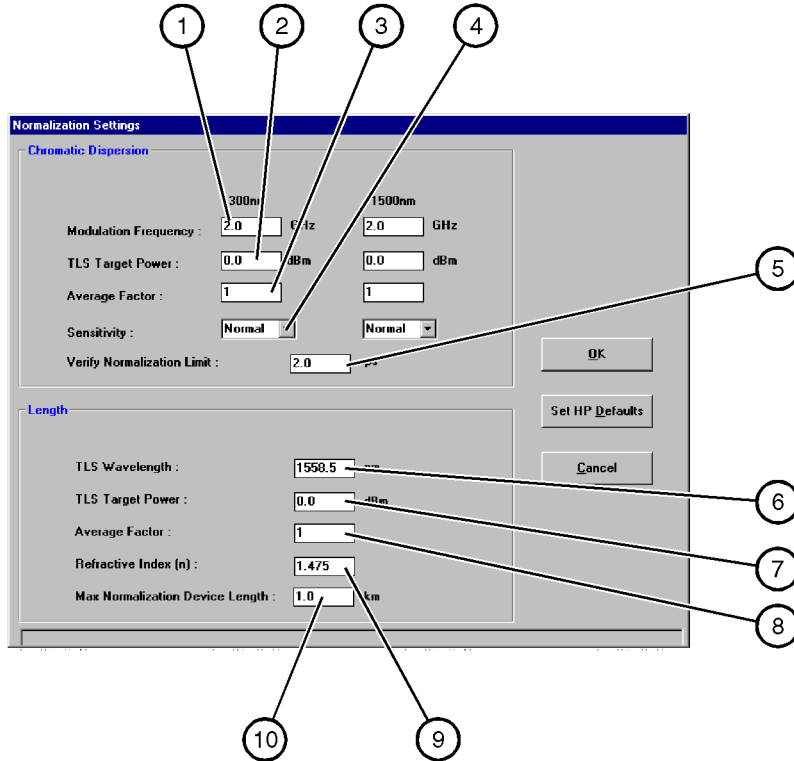

calsetdb

**Table 4-7. Calibration Settings Dialog Box**

| Item | TES Name                  | Parameter Location   | Type    | Comments   |
|------|---------------------------|--|---------|--|
| 1    | Test_Mod_Frequency_H<br>B | Group: New_Calibration<br>Test: Cal_Gain_Phase<br>Group: Verify_Calibration<br>Test: Verify_Gain_Phase | Single  |  |
| 2    | TLS_PowerLevel_HB         | Group: New_Calibration<br>Test: Cal_Gain_Phase<br>Group: Verify_Calibration<br>Test: Verify_Gain_Phase | Single  |  |
| 3    | VNA_AverageFactor_HB      | Group: New_Calibration<br>Test: Cal_Gain_Phase<br>Group: Verify_Calibration<br>Test: Verify_Gain_Phase | Integer |  |
| 4    | VNA_IFBandwidth_HB        | Group: New_Calibration<br>Test: Cal_Gain_Phase<br>Group: Verify_Calibration<br>Test: Verify_Gain_Phase | Integer | This parameter is "Sensitivity" on the GUI, but the tests need an IF bandwidth. The IF bandwidth number is stored in the database. Normal = 300. High = 100. Highest = 30. |
| 5    | Cal_Verify_Limit          | Test Plan:<br>Standard_Test_Plan   | Single  | This number is stored in seconds in the database.  |
| 6    | TLS_Wavelength            | Group: New_Calibration<br>Test: Cal_Length   | Single  |  |
| 7    | TLS_PowerLevel            | Group: New_Calibration<br>Test: Cal_Length   | Single  |  |
| 8    | VNA_AverageFactor         | Group: New_Calibration<br>Test: Cal_Length   | Integer |  |
| 9    | Refractive_Index          | Group: New_Calibration<br>Test: Cal_Length   | Double  |  |
| 10   | Cal_Len_MaxLength         | Test Plan:<br>Standard_Test_Plan   | Single  |  |

---

## New Normalization Button Dialog Box

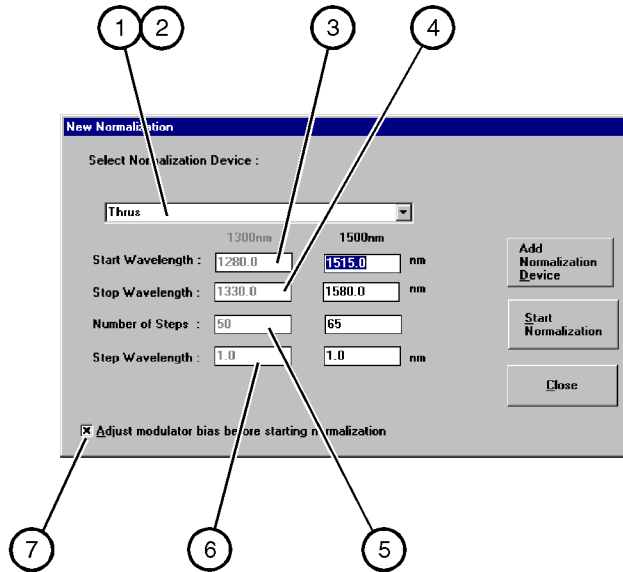

newbutn

**Table 4-8. New Normalization Button Dialog Box**

| Item | TES Name            | Parameter Location                                | Type                   | Comments   |
|------|---------------------|---|------------------------|--|
| 1    | Cal_Device          | Group:<br>New_Calibration                         | String Array<br>(0:99) | Drop down list of text entries for Cal Device. Selected by the operator. Selected item will be put in Selected_Device TES parameter. |
| 2    | Selected_Device     | System  | String                 | Item selected by operator from Cal_Device list.  |
| 3    | Start_Wavelength_HB | Group:<br>New_Calibration<br>Test: Cal_Gain_Phase | Single                 |  |
| 4    | Stop_Wavelength_HB  | Group:<br>New_Calibration<br>Test: Cal_Gain_Phase | Single                 |  |
| 5    | Number_Steps_HB     | Group:<br>New_Calibration<br>Test: Cal_Gain_Phase | Integer                |  |
| 6    |                     |   |                        |  |
| 7    | Cal_Mod_Bias        | Group: New_<br>Calibration                        | Boolean                | True = Adjust mod bias. False = Do not adjust mod bias.  |

## Power Monitor Setup Dialog Box

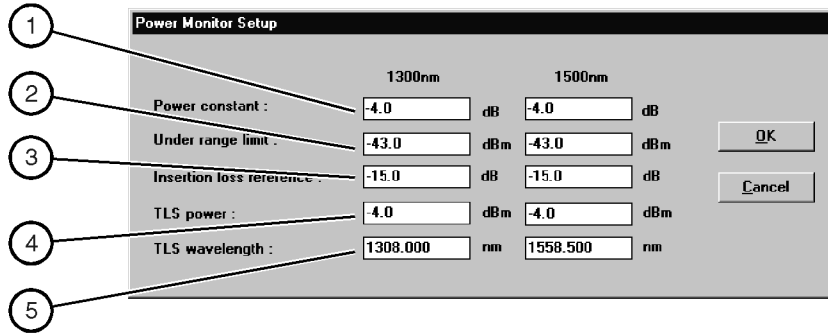

pwrmonit

**Table 4-9. Power Monitor Setup Dialog Box**

| Item | TES Name              | Parameter Location                          | Type   | Comments |
|------|-----------------------|---|--------|----------|
| 1    | PowerConstant_HB      | Group: Power Monitor<br>Test: Power Monitor | Single |          |
| 2    | Under_Range_Limit_HB  | Group: Power Monitor<br>Test: Power Monitor | Single |          |
| 3    | Insertion_Loss_Ref_HB | Group: Power Monitor<br>Test: Power Monitor | Single |          |
| 4    | TLS_PowerLevel_HB     | Group: Power Monitor<br>Test: Power Monitor | Single |          |
| 5    | TLS_Wavelength_HB     | Group: Power Monitor<br>Test: Power Monitor | Single |          |



## Various System Parameters

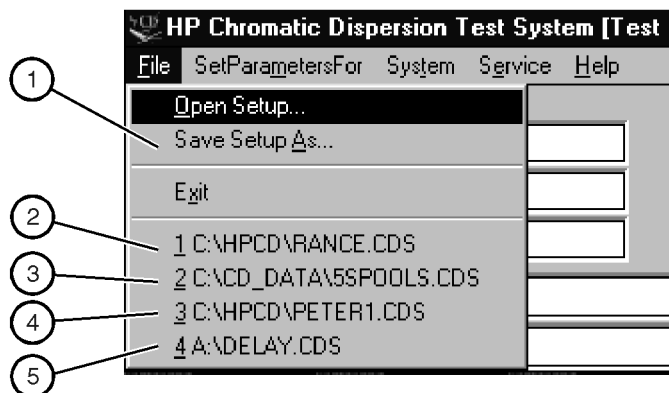

varsysp

**Table 4-10. Various System Parameters**

| Item | TES Name   | Parameter Location | Type   | Comments   |
|------|------------|--------------------|--------|--|
| 1    | Setup_Path | System:            | String | Path name where setup database files are located. Path entered here will be used by File pull-down list on Main GUI.     |
| 2    | Setup_1    | System:            | String | Name of last setup file that was saved or retrieved. This name will appear on File pull-down list on Main GUI.           |
| 3    | Setup_2    | System:            | String | Name of next to last setup file that was saved or retrieved. This name will appear on File pull-down list on Main GUI.   |
| 4    | Setup_3    | System:            | String | Name of second to last setup file that was saved or retrieved. This name will appear on File pull-down list on Main GUI. |
| 5    | Setup_4    | System:            | String | Name of third to last setup file that was saved or retrieved. This name will appear on File pull-down list on Main GUI.  |

## TES Min/Max Parameters

Table 4-11 defines the TES parameters in the database that are utilized by the GUI to check values entered in the GUI. All of these parameters are located at the “System” level. The table shows the parameters for a dual band system. For a single band system the parameters with “\_LB” and “\_HB” extensions will only appear once with either the “\_LB” or “\_HB” extension for a low band or high band system.

**Table 4-11. TES GUI Min/Max Parameters (1 of 3)**

| <b>TES Name</b>  | <b>Type</b> | <b>Value</b>  | <b>Unit</b> | <b>Description</b>                          |
|------------------|-------------|---------------|-------------|---|
| Vfy_MaxAvgFac    | Int32       | 999           |             | Max Average Factor limit for GUI            |
| Vfy_MaxCalLen    | Real64      | 1000000       | m           | Max Cal Length limit for GUI                |
| Vfy_MaxCalLim    | Real64      | 0.00000000009 | s           | Max Verify Cal Limit for GUI                |
| Vfy_MaxLen       | Real64      | 1000000       | m           | Max Length limit for GUI                    |
| Vfy_MaxLenRepeat | Int32       | 32767         |             | Max No. of Length meas. limit for GUI       |
| Vfy_MaxMaxCalLen | Real64      | 1000000       |             | Max Length limit for Cal for GUI            |
| Vfy_MaxModFreq   | Real64      | 3000000000    | Hz          | Max modulation frequency limit for GUI      |
| Vfy_MaxPMIL      | Real64      | 100           |             | Max Power Monitor insertion loss for GUI    |
| Vfy_MaxPMPC      | Real64      | 100           |             | Max Power Monitor power constant for GUI    |
| Vfy_MaxPMUR      | Real64      | 20            |             | Max Power Monitor under range limit for GUI |
| Vfy_MaxPrefWL    | Real32      | 3000          | nm          | Max value allowed in wavelength preferences |
| Vfy_MaxRI        | Real32      | 2             |             | Max Refractive Index limit for GUI          |
| Vfy_MaxSteps     | Int32       | 32767         |             | Max No. of Steps limit for GUI              |
| Vfy_MaxStepWave  | Real32      | 20            | nm          | Max Wavelength Step size limit for GUI      |

**Table 4-11. TES GUI Min/Max Parameters (2 of 3)**

| <b>TES Name</b>  | <b>Type</b> | <b>Value</b> | <b>Unit</b> | <b>Description</b>                               |
|------------------|-------------|--------------|-------------|--|
| Vfy_MaxTemp      | Real32      | 100000       | Degrees C   | Max Temperature limit for GUI                    |
| Vfy_MaxTLSPwr_HB | Real32      | 9.948        | dBm         | Max TLS Power Level for GUI                      |
| Vfy_MaxTLSPwr_LB | Real32      | 1.501        | dBm         | Max TLS Power Level for GUI                      |
| Vfy_MaxTLSTune   | Real32      | 10           | nm          | Max tuning accuracy for TLS enhanced mode        |
| Vfy_MaxTuneTries | Int16       | 100          |             | Max number of tuning tries for TLS enhanced mode |
| Vfy_MinAvgFac    | Int32       | 1            |             | Min Average Factor limit for GUI                 |
| Vfy_MinCalLim    | Real64      | 0            | s           | Min Verify Cal limit for GUI                     |
| Vfy_MinLen       | Real64      | 0.001        | m           | Min Length limit for GUI                         |
| Vfy_MinLenRepeat | Int32       | 1            |             | Min No. of Length meas. limit for GUI            |
| Vfy_MinMaxCalLen | Real64      | 0            |             | Min Length limit for Cal for GUI                 |
| Vfy_MinModFreq   | Real64      | 10000000     | Hz          | Min modulation frequency limit for GUI           |
| Vfy_MinPMIL      | Real64      | -50          |             | Min Power Monitor insertion loss for GUI         |
| Vfy_MinPMPC      | Real64      | -50          |             | Min Power Monitor power constant for GUI         |
| Vfy_MinPMUR      | Real64      | -100         |             | Min Power Monitor under range limit for GUI      |
| Vfy_MinPrefWL    | Real32      | 500          | nm          | Min value allowed in wavelength preferences      |
| Vfy_MinRI        | Int32       | 1            |             | Min Refractive Index limit for GUI               |
| Vfy_MinSteps     | Int32       | 5            |             | Min No. of Steps limit for GUI                   |
| Vfy_MinStepWave  | Real32      | 0.001        | Hz          | Min Wavelength Step size limit for GUI           |
| Vfy_MinTemp      | Real32      | -273.16      | Degrees C   | Min Temperature limit for GUI                    |
| Vfy_MinTLSPwr_HB | Real32      | -20          | dBm         | Min TLS Power Level for GUI                      |
| Vfy_MinTLSPwr_LB | Real32      | -20          | dBm         | Min TLS Power Level for GUI                      |
| Vfy_MinTLSTune   | Real32      | 0.0001       | nm          | Min tuning accuracy for TLS enhanced mode        |
| Vfy_MinTuneTries | Int16       | 1            |             | Min number of tuning tries for TLS enhanced mode |

**TES Min/Max Parameters****Table 4-11. TES GUI Min/Max Parameters (3 of 3)**

| <b>TES Name</b>  | <b>Type</b> | <b>Value</b> | <b>Unit</b> | <b>Description</b>                               |
|------------------|-------------|--------------|-------------|--|
| Vfy_MinCalLim    | Real64      | 0            | s           | Min Verify Cal limit for GUI                     |
| Vfy_MinLen       | Real64      | 0.001        | m           | Min Length limit for GUI                         |
| Vfy_MinLenRepeat | Int32       | 1            |             | Min No. of Length meas. limit for GUI            |
| Vfy_MinMaxCalLen | Real64      | 0            |             | Min Length limit for Cal for GUI                 |
| Vfy_MinModFreq   | Real64      | 10000000     | Hz          | Min modulation frequency limit for GUI           |
| Vfy_MinPMIL      | Real64      | -50          |             | Min Power Monitor insertion loss for GUI         |
| Vfy_MinPMPC      | Real64      | -50          |             | Min Power Monitor power constant for GUI         |
| Vfy_MinPMUR      | Real64      | -100         |             | Min Power Monitor under range limit for GUI      |
| Vfy_MinPrefWL    | Real32      | 500          | nm          | Min value allowed in wavelength preferences      |
| Vfy_MinRI        | Int32       | 1            |             | Min Refractive Index limit for GUI               |
| Vfy_MinSteps     | Int32       | 5            |             | Min No. of Steps limit for GUI                   |
| Vfy_MinStepWave  | Real32      | 0.001        | Hz          | Min Wavelength Step size limit for GUI           |
| Vfy_MinTemp      | Real32      | -273.16      | Degrees C   | Min Temperature limit for GUI                    |
| Vfy_MinTLSPwr_HB | Real32      | -20          | dBm         | Min TLS Power Level for GUI                      |
| Vfy_MinTLSPwr_LB | Real32      | -20          | dBm         | Min TLS Power Level for GUI                      |
| Vfy_MinTLSTune   | Real32      | 0.0001       | nm          | Min tuning accuracy for TLS enhanced mode        |
| Vfy_MinTuneTries | Int16       | 1            |             | Min number of tuning tries for TLS enhanced mode |

## Output Parameters

Table 4-12 and Table 4-13 give the names of the output parameters in the results.mdb database sorted by the type of system (single or dual band). For a single band 1300nm system, use the single band standard (1500nm) system names replacing the “\_HB” (High Band) terms shown in the table with “\_LB” (Low Band).

**Table 4-12. Output Parameters – Customer\_High\_Band (1 of 3)**

| Standard_Test_Plan          | Data Type | Unit | Description                                   |
|-----------------------------|-----------|------|---|
| <b>Test_Length</b>          |           |      |   |
| CableLength                 | Real64    | km   | Cable length measured (average for multiples) |
| CableLengthMeasurements(50) | Real64    | km   | Array of length measurements for multiples    |
| <b>Test_Gain_Phase</b>      |           |      |   |
| AbsGDelay_HB(1,1)           | Real64    | ps   | Absolute Group Delay at Stop Wavelength       |
| Filter_AbsGDelay(1,1,1)     | Real64    | ps   | Filter meas abs group delay array             |
| Filter_Wavelength(1,1,1)    | Real64    | nm   | Filter meas wavelength array                  |
| Gain_HB(1,1,1)              | Real64    | dBm  | Gain meas array                               |
| MaxModFreq_HB(1,1)          | Real64    | Hz   | Max mod frequency used for each test          |
| MinModFreq_HB(1,1)          | Real64    | Hz   | Min mod frequency used for each test          |
| NumGroups                   | Int32     |      | Number of groups completed                    |
| NumTests                    | Int32     |      | Number of tests in a group completed          |
| TauPhase_HB(1,1,1)          | Real64    | ps   | Relative Group Delay                          |
| TestTime(1,1)               | String    |      | Start Time of each test                       |

Remote Control  
**Output Parameters**

**Table 4-12. Output Parameters – Customer\_High\_Band (2 of 3)**

| <b>Standard_Test_Plan</b>       | <b>Data Type</b> | <b>Unit</b> | <b>Description</b>               |
|---------------------------------|------------------|-------------|----------------------------------|
| TLSPower_HB(1,1,1)              | Real64           | dB          | TLS power for each meas          |
| Wavelength_HB(1,1,1)            | Real64           | nm          | Gain/Phase meas wavelength array |
| <b>Test_CD</b>                  |                  |             |                                  |
| Dispersion_Coeff3Term_HB(1,1,1) | Real64           |             |                                  |
| Dispersion_Coeff5Term_HB(1,1,1) | Real64           |             |                                  |
| Dispersion_CoeffQuad_HB(1,1,1)  | Real64           |             |                                  |
| Dispersion_Measured_HB(1,1,1)   | Real64           | ps/nm       |                                  |
| Dispersion_Wavelength_HB(1,1,1) | Real64           | nm          |                                  |
| Gain_Corrected_HB(1,1,1)        | Real64           | dB          |                                  |
| Gain_FWHM_HB(1,1)               | Real64           | dB          |                                  |
| Number_Steps_HB                 | Int16            |             |                                  |
| Phase_Coeff3Term_HB(1,1,1)      | Real64           |             |                                  |
| Phase_Coeff5Term_HB(1,1,1)      | Real64           |             |                                  |
| Phase_CoeffQuad_HB(1,1,1)       | Real64           |             |                                  |
| Phase_StdDev3Term_HB(1,1)       | Real64           | ps          |                                  |
| Phase_StdDev5Term_HB(1,1)       | Real64           | ps          |                                  |
| Phase_StdDevQuad_HB(1,1)        | Real64           | ps          |                                  |
| TauPhase_Corrected_HB(1,1,1)    | Real64           | ps          |                                  |
| Test_Groups                     | Int16            |             |                                  |
| Tests_Per_Group                 | Int16            |             |                                  |
| Wavelength_Corrected_HB(1,1,1)  | Real64           | nm          |                                  |
| WL_GainPeak_HB(1,1)             | Real64           | nm          |                                  |
| ZeroWL_3Term_HB(1,1,1)          | Real64           | nm          |                                  |
| ZeroWL_5Term_HB(1,1,3)          | Real64           | nm          |                                  |

**Table 4-12. Output Parameters – Customer\_High\_Band (3 of 3)**

| <b>Standard_Test_Plan</b> | <b>Data Type</b> | <b>Unit</b>            | <b>Description</b> |
|---------------------------|------------------|------------------------|--------------------|
| ZeroWL_Quad_HB(1,1,1)     | Real64           | nm                     |                    |
| ZWLSlope_3Term_HB(1,1,1)  | Real64           | ps/<br>nm <sup>2</sup> |                    |
| ZWLSlope_5Term_HB(1,1,3)  | Real64           | ps/<br>nm <sup>2</sup> |                    |
| ZWLSlope_Quad_HB(1,1,1)   | Real64           | ps/<br>nm <sup>2</sup> |                    |

Remote Control  
**Output Parameters**

**Table 4-13. Output Parameters – Customer\_Dual\_Band (1 of 4)**

| <b>Standard_Test_Plan</b>   | <b>Data Type</b> | <b>Unit</b> | <b>Description</b>                            |
|-----------------------------|------------------|-------------|---|
| <b>Test Length</b>          |                  |             |   |
| CableLength                 | Real64           | km          | Cable length measured (average for multiples) |
| CableLengthMeasurements(50) | Real64           | km          | Array of length measurements for multiples    |
| <b>Test Gain Phase</b>      |                  |             |   |
| AbsGDelay_HB(1,1)           | Real64           | ps          | Absolute Group Delay at Stop Wavelength       |
| AbsGDelay_LB(1,1)           | Real64           | ps          | Absolute Group Delay at Stop Wavelength       |
| Filter_AbsGDelay(1,1,1)     | Real64           | ps          | Filter meas abs group delay array             |
| Filter_Wavelength(1,1,1)    | Real64           | nm          | Filter meas wavelength array                  |
| Gain_HB(1,1,1)              | Real64           | dBm         | Gain meas array                               |
| Gain_LB(1,1,1)              | Real64           | dBm         | Gain meas array                               |
| MaxModFreq_HB(1,1)          | Real64           | Hz          | Max mod frequency used for each test          |
| MaxModFreq_LB(1,1)          | Real64           | Hz          | Max mod frequency used for each test          |
| MinModFreq_HB(1,1)          | Real64           | Hz          | Min mod frequency used for each test          |
| MinModFreq_LB(1,1)          | Real64           | Hz          | Min mod frequency used for each test          |
| NumGroups                   | Int32            |             | Number of groups completed                    |
| NumTests                    | Int32            |             | Number of tests in a group completed          |
| TauPhase_HB(1,1,1)          | Real64           | ps          | Relative Group Delay                          |
| TauPhase_LB(1,1,1)          | Real64           | ps          | Relative Group Delay                          |
| TestTime(1,1)               | String           |             | Start Time of each test                       |
| TLSPower_HB(1,1,1)          | Real64           | dB          | TLS power for each meas                       |
| TLSPower_LB(1,1,1)          | Real64           | dB          | TLS power for each meas                       |
| Wavelength_HB(1,1,1)        | Real64           | nm          | Gain/Phase meas wavelength array              |
| Wavelength_LB(1,1,1)        | Real64           | nm          | Gain/Phase meas wavelength array              |



**Table 4-13. Output Parameters – Customer\_Dual\_Band (2 of 4)**

| <b>Standard_Test_Plan</b>         | <b>Data Type</b> | <b>Unit</b> | <b>Description</b> |
|-----------------------------------|------------------|-------------|--------------------|
| <b>Test_CD</b>                    |                  |             |                    |
| Dispersion_Coeff3Term_DUAL(1,1,1) | Real64           |             |                    |
| Dispersion_Coeff3Term_HB(1,1,1)   | Real64           |             |                    |
| Dispersion_Coeff3Term_LB(1,1,1)   | Real64           |             |                    |
| Dispersion_Coeff5Term_DUAL(1,1,1) | Real64           |             |                    |
| Dispersion_Coeff5Term_HB(1,1,1)   | Real64           |             |                    |
| Dispersion_Coeff5Term_LB(1,1,1)   | Real64           |             |                    |
| Dispersion_CoeffQuad_DUAL(1,1,1)  | Real64           |             |                    |
| Dispersion_CoeffQuad_HB(1,1,1)    | Real64           |             |                    |
| Dispersion_CoeffQuad_LB(1,1,1)    | Real64           |             |                    |
| Dispersion_Measured_DUAL(1,1,1)   | Real64           | ps/nm       |                    |
| Dispersion_Measured_HB(1,1,1)     | Real64           | ps/nm       |                    |
| Dispersion_Measured_LB(1,1,1)     | Real64           | ps/nm       |                    |
| Dispersion_Wavelength_DUAL(1,1,1) | Real64           | nm          |                    |
| Dispersion_Wavelength_HB(1,1,1)   | Real64           | nm          |                    |
| Dispersion_Wavelength_LB(1,1,1)   | Real64           | nm          |                    |
| Gain_Corrected_DUAL(1,1,1)        | Real64           | dB          |                    |
| Gain_Corrected_HB(1,1,1)          | Real64           | dB          |                    |
| Gain_Corrected_LB(1,1,1)          | Real64           | dB          |                    |
| Gain_FWHM_DUAL(1,1)               | Real64           | dB          |                    |
| Gain_FWHM_HB(1,1)                 | Real64           | dB          |                    |
| Gain_FWHM_LB(1,1)                 | Real64           | dB          |                    |
| Number_Steps_DUAL                 | Int16            |             |                    |
| Number_Steps_HB                   | Int16            |             |                    |

Remote Control  
**Output Parameters**

**Table 4-13. Output Parameters – Customer\_Dual\_Band (3 of 4)**

| <b>Standard_Test_Plan</b>      | <b>Data Type</b> | <b>Unit</b> | <b>Description</b> |
|--------------------------------|------------------|-------------|--------------------|
| Number_Steps_LB                | Int16            |             |                    |
| Phase_Coeff3Term_DUAL(1,1,1)   | Real64           |             |                    |
| Phase_Coeff3Term_HB(1,1,1)     | Real64           |             |                    |
| Phase_Coeff3Term_LB(1,1,1)     | Real64           |             |                    |
| Phase_Coeff5Term_DUAL(1,1,1)   | Real64           |             |                    |
| Phase_Coeff5Term_HB(1,1,1)     | Real64           |             |                    |
| Phase_Coeff5Term_LB(1,1,1)     | Real64           |             |                    |
| Phase_CoeffQuad_DUAL(1,1,1)    | Real64           |             |                    |
| Phase_CoeffQuad_HB(1,1,1)      | Real64           |             |                    |
| Phase_CoeffQuad_LB(1,1,1)      | Real64           |             |                    |
| Phase_StdDev3Term_DUAL(1,1)    | Real64           | ps          |                    |
| Phase_StdDev3Term_HB(1,1)      | Real64           | ps          |                    |
| Phase_StdDev3Term_LB(1,1)      | Real64           | ps          |                    |
| Phase_StdDev5Term_DUAL(1,1)    | Real64           | ps          |                    |
| Phase_StdDev5Term_HB(1,1)      | Real64           | ps          |                    |
| Phase_StdDev5Term_LB(1,1)      | Real64           | ps          |                    |
| Phase_StdDevQuad_DUAL(1,1)     | Real64           | ps          |                    |
| Phase_StdDevQuad_HB(1,1)       | Real64           | ps          |                    |
| Phase_StdDevQuad_LB(1,1)       | Real64           | ps          |                    |
| TauPhase_Corrected_DUAL(1,1,1) | Real64           | ps          |                    |
| TauPhase_Corrected_HB(1,1,1)   | Real64           | ps          |                    |
| TauPhase_Corrected_LB(1,1,1)   | Real64           | ps          |                    |
| Test_Groups                    | Int16            |             |                    |
| Tests_Per_Group                | Int16            |             |                    |

**Table 4-13. Output Parameters – Customer\_Dual\_Band (4 of 4)**

| <b>Standard_Test_Plan</b>        | <b>Data Type</b> | <b>Unit</b>        | <b>Description</b> |
|----------------------------------|------------------|--------------------|--------------------|
| Wavelength_Corrected_DUAL(1,1,1) | Real64           | nm                 |                    |
| Wavelength_Corrected_HB(1,1,1)   | Real64           | nm                 |                    |
| Wavelength_Corrected_LB(1,1,1)   | Real64           | nm                 |                    |
| WL_GainPeak_DUAL(1,1)            | Real64           | nm                 |                    |
| WL_GainPeak_HB(1,1)              | Real64           | nm                 |                    |
| WL_GainPeak_LB(1,1)              | Real64           | nm                 |                    |
| ZeroWL_3Term_DUAL(1,1,1)         | Real64           | nm                 |                    |
| ZeroWL_3Term_HB(1,1,1)           | Real64           | nm                 |                    |
| ZeroWL_3Term_LB(1,1,1)           | Real64           | nm                 |                    |
| ZeroWL_5Term_DUAL(1,1,3)         | Real64           | nm                 |                    |
| ZeroWL_5Term_HB(1,1,3)           | Real64           | nm                 |                    |
| ZeroWL_5Term_LB(1,1,3)           | Real64           | nm                 |                    |
| ZeroWL_Quad_DUAL(1,1,1)          | Real64           | nm                 |                    |
| ZeroWL_Quad_HB(1,1,1)            | Real64           | nm                 |                    |
| ZeroWL_Quad_LB(1,1,1)            | Real64           | nm                 |                    |
| ZWLSlope_3Term_DUAL(1,1,1)       | Real64           | ps/nm <sup>2</sup> |                    |
| ZWLSlope_3Term_HB(1,1,1)         | Real64           | ps/nm <sup>2</sup> |                    |
| ZWLSlope_3Term_LB(1,1,1)         | Real64           | ps/nm <sup>2</sup> |                    |
| ZWLSlope_5Term_DUAL(1,1,3)       | Real64           | ps/nm <sup>2</sup> |                    |
| ZWLSlope_5Term_HB(1,1,3)         | Real64           | ps/nm <sup>2</sup> |                    |
| ZWLSlope_5Term_LB(1,1,3)         | Real64           | ps/nm <sup>2</sup> |                    |
| ZWLSlope_Quad_DUAL(1,1,1)        | Real64           | ps/nm <sup>2</sup> |                    |
| ZWLSlope_Quad_HB(1,1,1)          | Real64           | ps/nm <sup>2</sup> |                    |
| ZWLSlope_Quad_LB(1,1,1)          | Real64           | ps/nm <sup>2</sup> |                    |



|  |      |
|--|------|
| Troubleshooting Common Problems                | 5-3  |
| Verification Tests                             | 5-9  |
| Reinstalling the System Software               | 5-16 |
| Agilent Technologies Support and Maintenance   | 5-18 |
| Cleaning Connections for Accurate Measurements | 5-20 |
| Electrostatic Discharge Information            | 5-30 |
| Returning the Instrument for Service           | 5-32 |
| Agilent Technologies Service Offices           | 5-35 |

---

## Maintenance

## Maintenance

This chapter shows you how to troubleshoot the system to the instrument level. To prevent voiding product warranty, do not remove any instrument covers. The Agilent 83427A chromatic dispersion test set is *not* customer serviceable. Do not open the Agilent 83427A's covers for any reason.

---

**WARNING**

---

**These servicing instructions are for use by qualified personnel only. To avoid electrical shock, do not perform any servicing unless you are qualified to do so.**

---

**WARNING**

---

**The opening of the system or removal of parts is likely to expose dangerous voltages. Disconnect the product from all voltage sources while it is being opened.**

---

**CAUTION**

---

The warranty and calibration will be voided on systems where the individual instruments, including fiber-optic cables, RF cables, or GPIB cables are removed by the customer. The system should only be disassembled by an Agilent Technologies Customer Engineer. Instruments should not be swapped or removed by non-Agilent Technologies personnel.

---

**WARNING**

---

**To prevent electric shock, disconnect the Agilent 86037B from mains before cleaning. Use a dry cloth or one slightly dampened with water to clean the external case parts. Do not attempt to clean internally.**

---

## Troubleshooting Common Problems

---

### **If some wavelengths measure 0 amplitude**

- Check the power (at the wavelength meter) at those wavelengths where the problem occurred. The power should measure greater than  $-25$  dBm.

The wavelength meter may not have an optical input level high enough to ensure correct operation.

---

### **If some wavelengths are grossly incorrect**

- Send the laser to Agilent Technologies for repair.

If the tunable laser source requires several seconds to settle at a selected wavelength, an erroneous wavelength meter reading may result.

---

### **If laser protection error occurs on TLS**

- Send the TLS back to Agilent Technologies for repair to ensure good long term performance of the system.

The TLS has degraded. To continue making measurements until repairs can be made, try lowering the target power by  $-2$  dBm and see if the problem goes away.

---

### **If the power is low**

- Check to make sure all the connectors are clean.
- Check the power from the tunable laser source directly at its output with an optical power meter. It should read very close to the power indicated on the front panel.

**If the RF signal power is low**

- Perform a modulator bias adjustment.
- 

**If the data looks incorrect**

- If the test path contains an optical amplifier, check for possible overdriving of the receiver input of the CD test set. The input level should be less than  $-3$  dBm. Also assure the measurement wavelength range is appropriate for the pass band of the amplified system.
- 

**If problems occur testing narrowband devices**

The five-term Sellmeier fit is generally inappropriate for very narrowband devices, such as Fabry-Perot filters. The result can be roughness in the fitted curve and multiple values of lambda zero. This is not a problem when testing fibers.

---

**If results of different curve fit models do not agree**

The three curve fit types differ in their ability to conform to the actual dispersion curve of the tested fiber. As a result, a variation on the order of a few hundredths to a few tenths of a nanometer can be observed in the value of lambda zero. The three-term Sellmeier curve fit tends to yield a lower lambda zero value than the other two fits.

Although the five-term Sellmeier curve fit has greater ability to fit the measured data, it is also more easily affected by noise. Therefore, the quadratic fit will generally give a more repeatable value of lambda zero. For most DSF, the mean values of lambda zero returned by the five-term and quadratic curve fits are in good agreement while the three-term fit yields a lower value.

---

**If fitted curve does not follow the actual data**

The shape of the curve fitted to the relative group delay data depends upon the device under test and the type of fit selected. Conditions of high DUT insertion loss, low DUT dispersion or narrow wavelength range can also affect the quality of the fit. The system will always try to fit the selected curve to the

---



data. Because the 5-term Sellmeier curve fit has more freedom to follow the shape of the data, it may display multiple zero dispersion wavelengths under some conditions.

The three types of curve fit are appropriate in different situations, as shown in the following table.

**Table 5-1. Types of Fitted Curves**

| <b>Wavelength Range of Measured Data</b> | <b>Type of Fiber</b>         | <b>Suggested Curve Fit</b> |
|--|------------------------------|----------------------------|
| 1300 nm                                  | non-dispersion shifted (SMF) | 3-term Sellmeier           |
|  | dispersion shifted (SMF/DS)  | Quadratic or 3-term        |
| 1500 nm                                  | non-dispersion shifted (SMF) | Quadratic or 3-term        |
|  | dispersion shifted (SMF/DS)  | Quadratic                  |
| 1300 and 1500 nm                         | non-dispersion shifted (SMF) | 5-term Sellmeier           |
|  | dispersion shifted (SMF/DS)  | 5-term Sellmeier           |

For most optical fibers, only the 5-term Sellmeier curve can provide a good fit over the combined (1300 and 1500 nm) wavelength ranges. A fitted 3-term Sellmeier or Quadratic curve follow the data quite closely in one wavelength range but diverge from the data in the other wavelength range. This is to be expected from the capabilities of the curve fit “model equations”.

---

**If fitted curve does not appear in relative group delay graph**

- Refer to “If fitted curve does not follow the actual data” on page 5-4.

Depending upon the device under test and the setup conditions, the fitted curve may closely follow the data in one of the wavelength ranges and diverge from the data in the other wavelength range. This is more likely to happen when the 3-term Sellmeier or Quadratic curve fit is applied to data collected in the combined wavelength ranges.

---

**To perform a quick check**

Common troubleshooting skills can be used to locate many problems. The following steps are suggested for quickly narrowing down the problem.

## Troubleshooting Common Problems

- 1 Inquire about recent repairs or changes to the system.

Often, this will help pinpoint current problems even if the system was operating correctly after the repair or change to the system.

- 2 Setup or reinstall the Agilent 86037B software to determine whether the problem is a hardware or a software problem. Refer to “Reinstalling the System Software” on page 5-16.

Refer to [Table 5-3 on page 5-8](#) for the correct addresses for the computer and the Agilent 86037B Chromatic Dispersion Test System. If reinstalling the software does not solve the problem, the problem may not be a software error.

- 3 Check that the system components are wired correctly.
- 4 Remove, clean, and reinstall all optical connections.
- 5 Ensure that all cables are secure.
- 6 Check for a 50Ω load at the back of each TLS.

---

### To check the TLS

---

#### WARNING

**Prevent any accidental exposure to the laser beam. Prior to disconnecting any optical fibers on the TLS, ensure that the TLS is turned off.**

- 1 Turn off the power on the TLS. Failure to comply can cause personal injury.
- 2 Remove the cable connecting the TLS to the test set.
- 3 Connect a short fiber-optic cable between the optical power meter and the TLS. The distance between the optical power meter and the TLS should be kept to a minimum.
- 4 Turn on the TLS.
- 5 If the TLS power measures low, the TLS needs repair.
- 6 Turn off the power on the TLS. Failure to comply can cause personal injury.
- 7 Remove the fiber-optic cable connecting the TLS and the optical power meter.
- 8 Reconnect the original fiber-optic cable that you removed in [Step 2](#).
- 9 Connect the open end of the fiber-optic cable to the optical power meter.
- 10 Turn on the TLS.
- 11 Test the TLS power. If the power measures low, replace the fiber-optic cable.

Otherwise, perform the procedure “To check the test set” on page 5-7.

---

### To check the test set

---

#### **WARNING**

**Prevent any accidental exposure to the laser beam. Prior to disconnecting any optical fibers on the TLS, ensure that the TLS is turned off.**

To accurately troubleshoot the system, make sure the TLS is working properly prior to testing the test set. Refer to “To check the TLS” on page 5-6.

- 1** Use a microscope to check the connections on the test set. Refer to “Cleaning Connections for Accurate Measurements” on page 5-20 for information on recognizing damaged connectors.
- 2** Run the self test for the Agilent 8753E Network Analyzer. Refer to “To run the network analyzer self test” on page 5-10. If the self test passes, troubleshoot the test set. If the test fails, the network analyzer needs repair

---

### To check the computer

- For problems with the personal computer that are unrelated to the rest of the Agilent 86037B, refer to the computer manual that was shipped with this system, or call your local IT department.
- Troubleshoot the computer’s connection to the Agilent 86037B:
  - a** Make sure that the BNC cable (or a serial cable on the dual band system) is connected to the test set properly.
  - b** Ensure that the GPIB and computer addresses are correct. The correct GPIB and I/O addresses for the computer and system are located in [Table 5-3 on page 5-8](#) and [Table 5-2 on page 5-8](#).
- Perform the following steps:
  - a** Disconnect the BNC cable (or a serial cable on the dual band system) from the test set.
  - b** With a voltage meter, measure the voltage from the cable. It should be reading between 2 and 4 volts.

**To check the network**

- Make sure the LAN cable is connected properly to the computer.
- Setup the computer LAN card according to the manufacturer's specifications.
- Disconnect the LAN cable, and test it using a LAN cable testing tool.
- Refer to the Windows NT documentation on networking the system. The Windows NT help system also contains a *Networking Troubleshooter* section which will guide you through the most common networking problems.
- Refer to your local IT department, or call the Agilent Technologies Test and Measurement Customer Support line at (800) 452-4844.
- Correct GPIB and I/O addresses for the computer and system are located in [Table 5-3 on page 5-8](#) and [Table 5-2 on page 5-8](#).

There are many types of inter-office LANs. Because of this, this manual can only give very basic troubleshooting information.

**Table 5-2. Computer I/O Addresses**

| <b>Test Set Component</b> | <b>I/O Address</b>                     |
|---------------------------|--|
| Modulation Bias DAC       | &h300                                  |
| Switch DAC                | &h308 (Only used in dual band systems) |

**Table 5-3. GPIB Addresses**

| <b>Instrument Name</b>        | <b>GPIB Address</b> |
|-------------------------------|---------------------|
| Tunable Laser Source - 1500nm | 24                  |
| Tunable Laser Source - 1300nm | 23                  |
| Wavelength Meter              | 25                  |
| Network Analyzer              | 16                  |

## Verification Tests

### To run the tunable laser source self test

- On the tunable laser source, press the *SelfTst* softkey.

The instrument performs a full self test which tests various assemblies in the instrument. If the self test fails, three short beeps sounds with the message *Self test . . . . . failed*. The instrument will continue to operate to the extent of its capabilities.

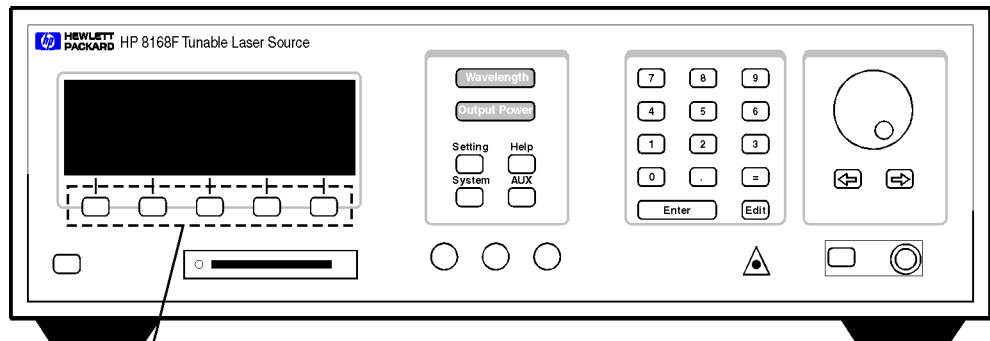

Softkeys

hp168f\_1.cdr

**Figure 5-1. The Agilent 8168E/F Tunable Laser Source**

**Table 5-4. Self Tests**

| Test Name | Test Description                       |
|-----------|--|
| μP1 Board | Tests the first microprocessor board.  |
| μP2 Board | Tests the second microprocessor board. |

**Table 5-4. Self Tests (Continued)**

| Test Name        | Test Description  |
|------------------|---|
| Calibration Data | Tests the calibration data stored in the instrument.                    |
| HW-Interface     | Tests the hardware interface.   |
| ADC              | Tests the analog to digital converter.                                  |
| Laser Board      | Tests the laser driver board.   |
| Motor 1          | Tests the first of two motors used to control the tuning of the laser.  |
| Motor 2          | Tests the second of two motors used to control the tuning of the laser. |
| Motor 3          | Tests the motor used to control the attenuation.                        |

**To run the network analyzer self test**

- 1 On the Agilent 8753 network analyzer, disconnect all devices and peripherals (including all test set interconnects).
- 2 Turn the network analyzer, and press the Preset key.

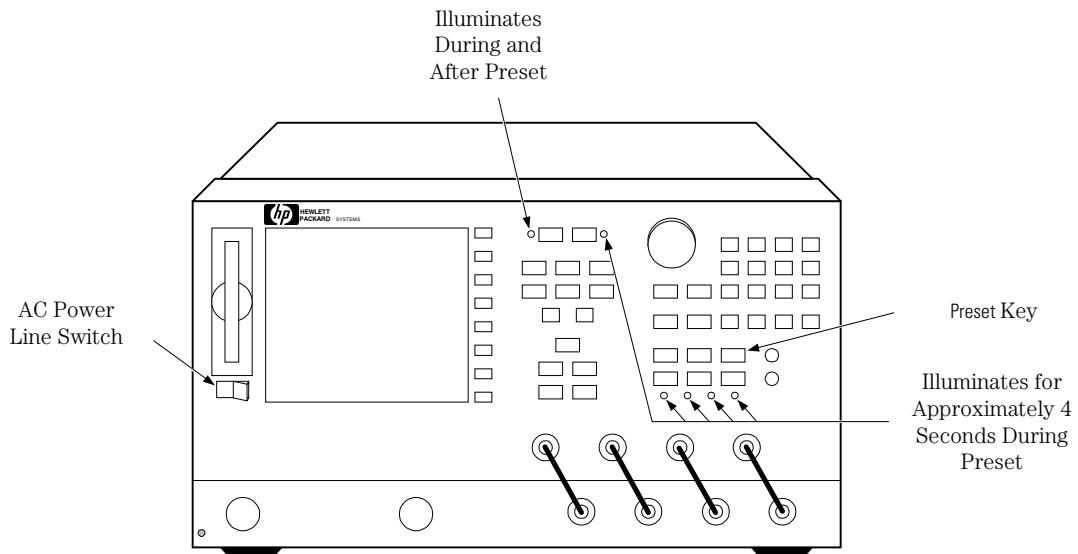

**Figure 5-2. Self Test for the Agilent 8753 Network Analyzer**

- 3 After the Preset is complete, the following parameters appear on the network analyzer's display: CH1, S11, log MAG, 10dB, REF 0dB, START 30kHz, STOP 3GHz (or 6GHz for Option 006).

If the self test fails, refer to the Agilent 8753E Network Analyzer service manual for instructions on testing the individual components of the network analyzer, or call your Agilent Technologies service center.

### To run the network analyzer operator's check

The operator's check determines that the source is phase locked across the entire frequency range and that all three samplers are functioning properly.

**Table 5-5. Equipment Required**

| Equipment              | Agilent Model Number |
|------------------------|----------------------|
| 20 dB attenuator       | 8491A Option 020     |
| RF cable set           | 11851B               |
| Two-way power schooner | 11667A Option 001    |

**Figure 5-3. Operator's Check for the Agilent 8753 Network Analyzer**

- 1 Disconnect all devices, peripherals, and accessories (including adapters and limiters) from the Agilent 8753 network analyzer.
- 2 Switch on the network analyzer.
- 3 Press the Preset button on the network analyzer.
- 4 Press the System button on the network analyzer.
- 5 On the network analyzer:
  - a Press the softkey corresponding to the *Service* menu.
  - b Press the softkey corresponding to the *Tests* menu.
  - c Enter, 21, on the network analyzer keypad.
  - d Press the, x1, button on the network analyzer.
  - e Press the softkey corresponding to the *External Tests* function.
- 6 Press the Execute Test key on the network analyzer.
- 7 At the prompt, connect the equipment as shown in [Figure 5-5](#), with power to

**Verification Tests**

inputs R and A. Press the *Continue* softkey as prompted until the analyzer displays PASS or FAIL.

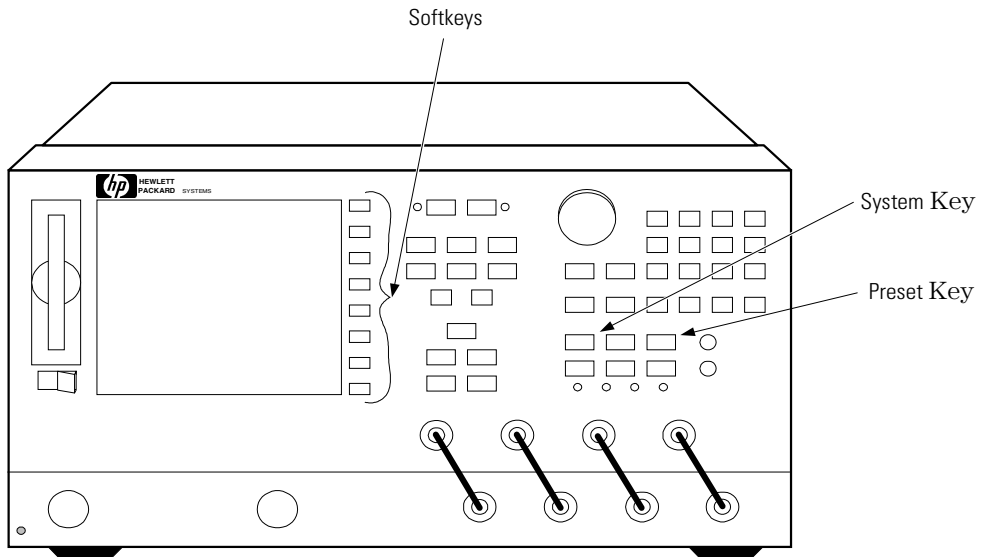
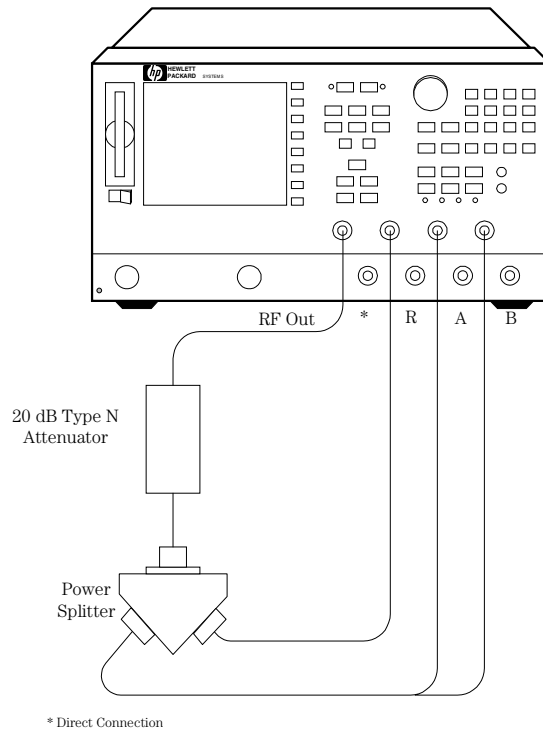

**Figure 5-4. Operator's Check for the Agilent 8753 Network Analyzer**

- 8 Press 22 and then the x1 button on the network analyzer to access the input R and B operator's check. When the title appears, press the *Execute Test* softkey. Move the RF cable from input A to B. Press the *Continue* softkey as prompted until the analyzer displays PASS or FAIL.
- 9 If the operator's check fails:
  - Recheck the equipment configuration and connections.
  - Confirm the attenuator, splitter, and cables meet their published specifications. Visually inspect the connectors.

Refer to the Agilent 8753E network analyzer service manual for instructions on testing the individual components of the network analyzer, or call your Agilent Technologies service center.





**Figure 5-5. Operator's Check Setup**

---

### To run the network analyzer GPIB systems check

The following steps test the network analyzer's GPIB functions with a known working passive peripheral such as a plotter, printer, or disk drive.

- 1 Connect the peripheral to the network analyzer using a good GPIB cable.
- 2 Press the *Local* button, then the *System Controller* softkey to enable the analyzer to control the peripheral.
- 3 Press the *Set Addresses* softkey and the appropriate softkeys to verify that the device addresses will be recognized by the analyzer. The factory default addresses are listed in [Table 5-6](#).

**Verification Tests**

You may use other addresses with two provisions: 1) each device must have its own address, and 2) the address set on each device must match the one recognized by the network analyzer (and displayed). Peripheral addresses are often set with a rear panel switch. Refer to the manual of the peripheral to read or change its address.

**Table 5-6. GPIB Addresses**

| <b>Device</b>       | <b>GPIB Address</b> |
|---------------------|---------------------|
| Agilent 8753E       | 16                  |
| Plotter port - GPIB | 5                   |
| Printer port - GPIB | 1                   |
| Disk (external)     | 0                   |
| Controller          | 21                  |
| Power meter - GPIB  | 13                  |

- 4** If you are using a plotter or printer, ensure that it is set up correctly:
  - a** Turn the plotter or printer on, and check that the pens and paper are loaded.
  - b** Set the plotter's pinch wheels down, and if needed set the P1 and P2 positions set.
  - c** Press the copy button, then the *Plot* or *Print Monochrome* softkeys. If the result is a copy of the network analyzer display, the printing/plotting features are functional in the analyzer. If the printer or plotter does not print correctly, suspect the GPIB function of the analyzer. Refer to the troubleshooting section of the Agilent 8753E service manual.
- 5** Select the external disk drive. Press the Save/Recall button, then the *Select Disk* and *External Disk* softkeys.
- 6** Verify that the address is set correctly. Press the Local button, then the *Set Addresses* and *Address:Disk*.
- 7** Ensure that the disk drive is set up correctly:
  - a** Turn the disk drive on, and place an initialized disk in the correct drive.
  - b** Enter the correct disk unit number and volume number (press the Local button to access the softkeys that display the numbers; default is 0 for both).

- c** With hard disk (Winchester) drives, make sure the configuration switch is properly set. Refer to the drive's manual.
- 8** Press the Start button, 1 on the number pad, M/ $\mu$  button, the Save/Recall button, then the *Save State* softkey. Then press the Preset button, Save/Recall button, then the *Recall State* softkey.
  - a** If the resultant trace starts at 1 MHz, GPIB is functional in the analyzer.
  - b** If the resultant trace does not start at 1 MHz, suspect the GPIB function of the analyzer. Refer to the troubleshooting section of the Agilent 8753E service manual.

---

## Reinstalling the System Software

This section shows you how to reinstall the chromatic dispersion, National Instruments 488, and remote shell software. The DAC02 and National Instruments 488 software must be installed in order to run the Agilent 86037B. The remote shell software must be installed in order to run the Agilent 86037B in remote mode. The files necessary to install the chromatic dispersion software, NI-488 code, and remote shell service are in the subdirectory named `Related Instructions` located under the main install directory. The file and directory structure is listed below:

```
\DAC02
  Port95NT.exe
\NI-488
  version.txt
  \disk1
    ...
    setup.exe
    ...
  \disk2
    ...
\RSH
  rsh_start.bat
  rshsetup.exe
  rshsvc.dll
  rshsvc.exe
  rshsvc.txt – Instructions for installation
```

---

### To install the NI-488 code

- 1 Run the file `setup.exe` from the `disk1` directory
- 2 Click custom installation from the setup program
- 3 Click only the `driver` option. After the installation is finished, run the GPIB utility which is found as the GPIB icon in the control panel. When the GPIB utility window is displayed, select `OK`. When the next window is displayed, select `Yes`

**To install the DAC02 code**

- 1** Run the file `Port95NT.exe` from the DAC02 directory and click **Yes** at the prompt
- 2** Click `custom installation` from the setup program and select only the relevant files.
- 3** When the process is complete, reboot the computer.

---

**To install the chromatic dispersion test system software**

- For a single band, 1300 nm Agilent 86037B, run the file `CD_Low_Band.exe` from the CD-ROM disk.
- For a high band, 1550 nm Agilent 86037B, run the file `CD_High_Band.exe` from the CD-ROM disk.
- For a dual band Agilent 86037B, run the file `CD_Dual_Band.exe` from the CD-ROM disk.

## Agilent Technologies Support and Maintenance

On-site service by an Agilent Technologies customer engineer is available to ensure that your system uptime is maximized. You can order per-incident, contractual, or customized on-site system repair and on-site system calibration services. Just contact your local sales office, and give the operator the name of your company and the city where you're located. Then, ask to speak with a field sales engineer. If you're currently covered by a per-incident, contractual or customized program, contact your customer engineer through your local sales office to obtain on-site service.

### ***On-site System Repair***

When you order one of Agilent Technologies' on-site system repair options, a customer engineer (CE) is assigned to your company. The CE becomes intimately acquainted with your environment and assumes personal responsibility for managing your system's maintenance program. Your CE will also perform preventive maintenance on a regular basis.

Agilent Technologies offers four distinct levels of support for system repair:

- **Priority Plus** – Repair service 24 hours a day, seven days a week. Customers within 100 miles of an Agilent Technologies support facility receive an on-site visit within four hours
- **Priority** – On-site coverage from 8:00 a.m. to 9:00 p.m. Monday through Friday, excluding Agilent Technologies holidays; allows scheduled maintenance to be performed after normal working hours. Customers within 100 miles of an Agilent Technologies support facility receive an on-site visit within four hours
- **Next Day** – Provides next-day coverage from 8:00 a.m. to 5:00 p.m. Monday through Friday, excluding Agilent Technologies holidays, for customers within 100 miles of an Agilent Technologies support facility
- **Cooperative** – For customers who maintain their own systems and rely on Agilent Technologies for training, replacement parts, diagnostic support tools, repair documentation, and remote backup support. Available for customers with specific systems, spares and personnel. (Ask your sales representative about prerequisites)

All levels are subject to volume discount pricing. In addition, if you purchase Priority or Next Day support and have a critical support need, you can order a faster response time for an additional fixed charge when you have an open purchase order on file with Agilent Technologies.

### ***On-Site System Calibration***

When you order an on-site calibration agreement as part of your on-site system repair program, your assigned customer engineer (CE) will perform calibrations on your system at the same level of quality that is applied to instruments that are returned to Agilent Technologies.

Calibration services for systems include the following:

- Calibration measurements traceable to national and international standards
- U.S. measurements traceable to the National Institute of Standards and Technology (NIST)
- Product performance compared to standards of known accuracy to ensure conformance with published specifications
- Calibration at Agilent Technologies-recommended intervals
- Complete data reports for all measured product performance
- Calibration certificate and sticker showing date of next scheduled calibration
- Calibration at no charge after a repair performed by Agilent Technologies on products covered under a calibration agreement or under Agilent Technologies Support Options

### ***Other Test and Measurement Support Programs***

In addition to Hardware Support, the Test and Measurement division offers a wide range of other service and support programs.

- Software Support
- Application Consulting and Training
- Solution Engineering and Manufacturing Process Consulting

## Cleaning Connections for Accurate Measurements

Today, advances in measurement capabilities make connectors and connection techniques more important than ever. Damage to the connectors on calibration and verification devices, test ports, cables, and other devices can degrade measurement accuracy and damage instruments. Replacing a damaged connector can cost thousands of dollars, not to mention lost time! This expense can be avoided by observing the simple precautions presented in this book. This book also contains a brief list of tips for caring for electrical connectors.

---

## Choosing the Right Connector

A critical but often overlooked factor in making a good lightwave measurement is the selection of the fiber-optic connector. The differences in connector types are mainly in the mechanical assembly that holds the ferrule in position against another identical ferrule. Connectors also vary in the polish, curve, and concentricity of the core within the cladding. Mating one style of cable to another requires an adapter. Agilent Technologies offers adapters for most instruments to allow testing with many different cables. [Figure 5-6 on page 5-21](#) shows the basic components of a typical connectors.

The system tolerance for reflection and insertion loss must be known when selecting a connector from the wide variety of currently available connectors. Some items to consider when selecting a connector are:

- How much insertion loss can be allowed?
- Will the connector need to make multiple connections? Some connectors are better than others, and some are very poor for making repeated connections.
- What is the reflection tolerance? Can the system take reflection degradation?
- Is an instrument-grade connector with a precision core alignment required?
- Is repeatability tolerance for reflection and loss important? Do your specifica-



tions take repeatability uncertainty into account?

- Will a connector degrade the return loss too much, or will a fusion splice be required? For example, many DFB lasers cannot operate with reflections from connectors. Often as much as 90 dB isolation is needed.

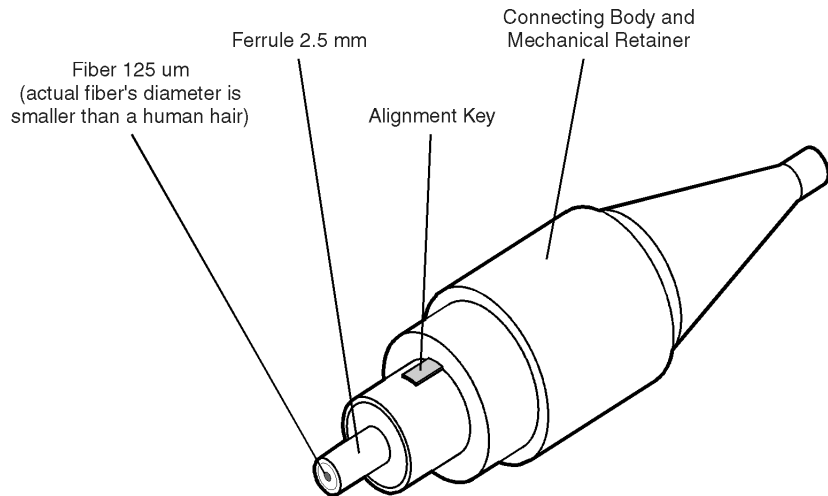

**Figure 5-6. Basic components of a connector.**

Over the last few years, the FC/PC style connector has emerged as the most popular connector for fiber-optic applications. While not the highest performing connector, it represents a good compromise between performance, reliability, and cost. If properly maintained and cleaned, this connector can withstand many repeated connections.

However, many instrument specifications require tighter tolerances than most connectors, including the FC/PC style, can deliver. These instruments cannot tolerate connectors with the large non-concentricities of the fiber common with ceramic style ferrules. When tighter alignment is required, Agilent Technologies instruments typically use a connector such as the Diamond HMS-10, which has concentric tolerances within a few tenths of a micron. Agilent Technologies then uses a special universal adapter, which allows other cable types to mate with this precision connector. See [Figure 5-7](#).

**Cleaning Connections for Accurate Measurements****Figure 5-7. Universal adapters to Diamond HMS-10.**

The HMS-10 encases the fiber within a soft nickel silver (Cu/Ni/Zn) center which is surrounded by a tough tungsten carbide casing, as shown in [Figure 5-8](#).

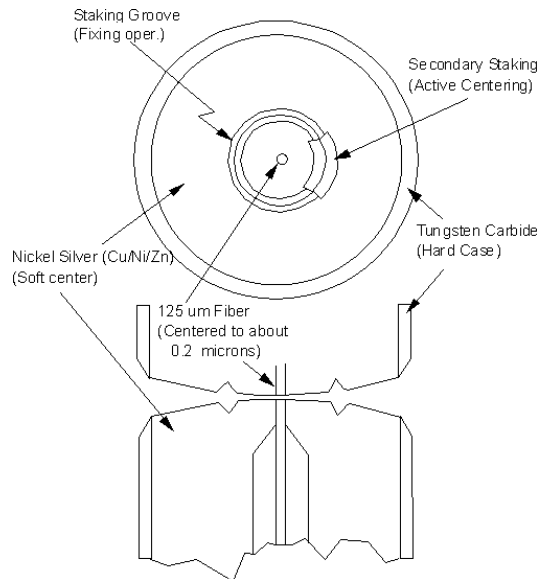
**Figure 5-8. Cross-section of the Diamond HMS-10 connector.**

The nickel silver allows an active centering process that permits the glass fiber to be moved to the desired position. This process first stakes the soft nickel silver to fix the fiber in a near-center location, then uses a post-active staking to shift the fiber into the desired position within 0.2 μm. This process, plus the keyed axis, allows very precise core-to-core alignments. This connector is found on most Agilent Technologies lightwave instruments.

The soft core, while allowing precise centering, is also the chief liability of the connector. The soft material is easily damaged. Care must be taken to minimize excessive scratching and wear. While minor wear is not a problem if the glass face is not affected, scratches or grit can cause the glass fiber to move out of alignment. Also, if unkeyed connectors are used, the nickel silver can be pushed onto the glass surface. Scratches, fiber movement, or glass contamination will cause loss of signal and increased reflections, resulting in poor return loss.

---

## Inspecting Connectors

Because fiber-optic connectors are susceptible to damage that is not immediately obvious to the naked eye, poor measurements result without the user being aware. Microscopic examination and return loss measurements are the best way to ensure good measurements. Good cleaning practices can help ensure that optimum connector performance is maintained. With glass-to-glass interfaces, any degradation of a ferrule or the end of the fiber, any stray particles, or finger oil can have a significant effect on connector performance. Where many repeat connections are required, use of a connector saver or patch cable is recommended.

[Figure 5-9](#) shows the end of a clean fiber-optic cable. The dark circle in the center of the micrograph is the fiber's 125  $\mu\text{m}$  core and cladding which carries the light. The surrounding area is the soft nickel-silver ferrule. [Figure 5-10](#) shows a dirty fiber end from neglect or perhaps improper cleaning. Material is smeared and ground into the end of the fiber causing light scattering and poor reflection. Not only is the precision polish lost, but this action can grind off the glass face and destroy the connector.

[Figure 5-11](#) shows physical damage to the glass fiber end caused by either repeated connections made without removing loose particles or using improper cleaning tools. When severe, the damage of one connector end can be transferred to another good connector endface that comes in contact with the damaged one. Periodic checks of fiber ends, and replacing connecting cables after many connections is a wise practice.

The cure for these problems is disciplined connector care as described in the following list and in "Cleaning Connectors" on page 5-27.

### **Cleaning Connections for Accurate Measurements**

Use the following guidelines to achieve the best possible performance when making measurements on a fiber-optic system:

- Never use metal or sharp objects to clean a connector and never scrape the connector.
- Avoid matching gel and oils.

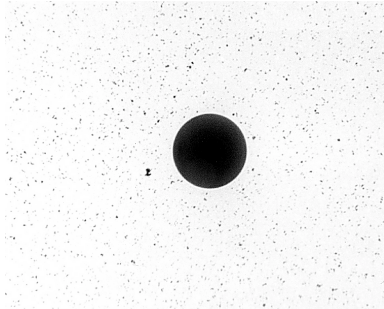

**Figure 5-9. Clean, problem-free fiber end and ferrule.**

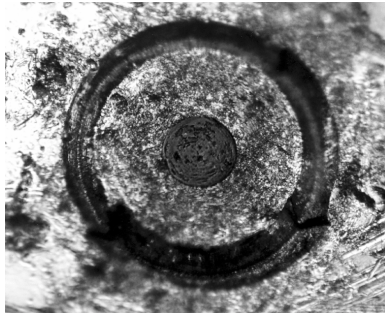

**Figure 5-10. Dirty fiber end and ferrule from poor cleaning.**

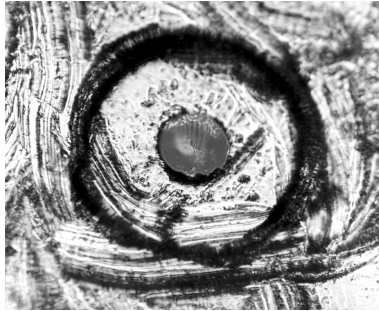

**Figure 5-11. Damage from improper cleaning.**

While these often work well on first insertion, they are great dirt magnets. The oil or gel grabs and holds grit that is then ground into the end of the fiber. Also, some early gels were designed for use with the FC, non-contacting connectors, using small glass spheres. When used with contacting connectors, these glass balls can scratch and pit the fiber. If an index matching gel or oil must be used, apply it to a freshly cleaned connector, make the measurement, and then immediately clean it off. Never use a gel for longer-term connections and never use it to improve a damaged connector. The gel can mask the extent of damage and continued use of a damaged fiber can transfer damage to the instrument.

- When inserting a fiber-optic cable into a connector, gently insert it in as straight a line as possible. Tipping and inserting at an angle can scrape material off the inside of the connector or even break the inside sleeve of connectors made with ceramic material.
- When inserting a fiber-optic connector into a connector, make sure that the fiber end does not touch the outside of the mating connector or adapter.
- Avoid over tightening connections.

Unlike common electrical connections, tighter is *not* better. The purpose of the connector is to bring two fiber ends together. Once they touch, tightening only causes a greater force to be applied to the delicate fibers. With connectors that have a convex fiber end, the end can be pushed off-axis resulting in misalignment and excessive return loss. Many measurements are actually improved by backing off the connector pressure. Also, if a piece of grit does happen to get by the cleaning procedure, the tighter connection is more likely to damage the glass. Tighten the connectors just until the two fibers touch.

### **Cleaning Connections for Accurate Measurements**

- Keep connectors covered when not in use.
- Use fusion splices on the more permanent critical nodes. Choose the best connector possible. Replace connecting cables regularly. Frequently measure the return loss of the connector to check for degradation, and clean every connector, every time.

All connectors should be treated like the high-quality lens of a good camera. The weak link in instrument and system reliability is often the inappropriate use and care of the connector. Because current connectors are so easy to use, there tends to be reduced vigilance in connector care and cleaning. It takes only one missed cleaning for a piece of grit to permanently damage the glass and ruin the connector.

#### ***Measuring insertion loss and return loss***

Consistent measurements with your lightwave equipment are a good indication that you have good connections. Since return loss and insertion loss are key factors in determining optical connector performance they can be used to determine connector degradation. A smooth, polished fiber end should produce a good return-loss measurement. The quality of the polish establishes the difference between the “PC” (physical contact) and the “Super PC” connectors. Most connectors today are physical contact which make glass-to-glass connections, therefore it is critical that the area around the glass core be clean and free of scratches. Although the major area of a connector, excluding the glass, may show scratches and wear, if the glass has maintained its polished smoothness, the connector can still provide a good low level return loss connection.

If you test your cables and accessories for insertion loss and return loss upon receipt, and retain the measured data for comparison, you will be able to tell in the future if any degradation has occurred. Typical values are less than 0.5 dB of loss, and sometimes as little as 0.1 dB of loss with high performance connectors. Return loss is a measure of reflection: the less reflection the better (the larger the return loss, the smaller the reflection). The best physically contacting connectors have return losses better than 50 dB, although 30 to 40 dB is more common.

***Visual inspection of fiber ends***

Visual inspection of fiber ends can be helpful. Contamination or imperfections on the cable end face can be detected as well as cracks or chips in the fiber itself. Use a microscope (100X to 200X magnification) to inspect the entire end face for contamination, raised metal, or dents in the metal as well as any other imperfections. Inspect the fiber for cracks and chips. Visible imperfections not touching the fiber core may not affect performance (unless the imperfections keep the fibers from contacting).

**WARNING**

**Always remove both ends of fiber-optic cables from any instrument, system, or device before visually inspecting the fiber ends. Disable all optical sources before disconnecting fiber-optic cables. Failure to do so may result in permanent injury to your eyes.**

---

## Cleaning Connectors

The procedures in this section provide the proper steps for cleaning fiber-optic cables and Agilent Technologies universal adapters. The initial cleaning, using the alcohol as a solvent, gently removes any grit and oil. If a caked-on layer of material is still present, (this can happen if the beryllium-copper sides of the ferrule retainer get scraped and deposited on the end of the fiber during insertion of the cable), a second cleaning should be performed. It is not uncommon for a cable or connector to require more than one cleaning.

**CAUTION**

Agilent Technologies strongly recommends that index matching compounds *not* be applied to their instruments and accessories. Some compounds, such as gels, may be difficult to remove and can contain damaging particulates. If you think the use of such compounds is necessary, refer to the compound manufacturer for information on application and cleaning procedures.

**Table 5-7. Cleaning Accessories**

| Item   | Agilent Part Number |
|--|---------------------|
| Any commercially available denatured alcohol | —                   |
| Cotton swabs                                 | 8520-0023           |
| Small foam swabs                             | 9300-1223           |
| Compressed dust remover (non-residue)        | 8500-5262           |

**Cleaning Connections for Accurate Measurements****Table 5-8. Dust Caps Provided with Lightwave Instruments**

| <b>Item</b>       | <b>Agilent Part Number</b> |
|-------------------|----------------------------|
| Laser shutter cap | 08145-64521                |
| FC/PC dust cap    | 08154-44102                |
| Biconic dust cap  | 08154-44105                |
| DIN dust cap      | 5040-9364                  |
| HMS10/dust cap    | 5040-9361                  |
| ST dust cap       | 5040-9366                  |

***To clean a non-lensed connector*****CAUTION**

Do not use any type of foam swab to clean optical fiber ends. Foam swabs can leave filmy deposits on fiber ends that can degrade performance.

- 1** Apply pure isopropyl alcohol to a clean lint-free cotton swab or lens paper.  
Cotton swabs can be used as long as no cotton fibers remain on the fiber end after cleaning.
- 2** Clean the ferrules and other parts of the connector while avoiding the end of the fiber.
- 3** Apply isopropyl alcohol to a new clean lint-free cotton swab or lens paper.
- 4** Clean the fiber end with the swab or lens paper.  
Do *not* scrub during this initial cleaning because grit can be caught in the swab and become a gouging element.
- 5** Immediately dry the fiber end with a clean, dry, lint-free cotton swab or lens paper.
- 6** Blow across the connector end face from a distance of 6 to 8 inches using filtered, dry, compressed air. Aim the compressed air at a shallow angle to the fiber end face.

Nitrogen gas or compressed dust remover can also be used.



---

**CAUTION**

---

Do not shake, tip, or invert compressed air canisters, because this releases particles in the can into the air. Refer to instructions provided on the compressed air canister.

- 7 As soon as the connector is dry, connect or cover it for later use.

If the performance, after the initial cleaning, seems poor try cleaning the connector again. Often a second cleaning will restore proper performance. The second cleaning should be more arduous with a scrubbing action.

***To clean an adapter***

The fiber-optic input and output connectors on many Agilent Technologies instruments employ a universal adapter such as those shown in the following picture. These adapters allow you to connect the instrument to different types of fiber-optic cables.



**Figure 5-12. Universal adapters.**

- 1 Apply isopropyl alcohol to a clean foam swab.

Cotton swabs can be used as long as no cotton fibers remain after cleaning. The foam swabs listed in this section's introduction are small enough to fit into adapters.

Although foam swabs can leave filmy deposits, these deposits are very thin, and the risk of other contamination buildup on the inside of adapters greatly outweighs the risk of contamination by foam swabs.

- 2 Clean the adapter with the foam swab.
- 3 Dry the inside of the adapter with a clean, dry, foam swab.
- 4 Blow through the adapter using filtered, dry, compressed air.

Nitrogen gas or compressed dust remover can also be used. Do not shake, tip, or invert compressed air canisters, because this releases particles in the can into the air. Refer to instructions provided on the compressed air canister.

## Electrostatic Discharge Information

Electrostatic discharge (ESD) can damage or destroy electronic components. All work on electronic assemblies should be performed at a static-safe work station. The following figure shows an example of a static-safe work station using two types of ESD protection:

- Conductive table-mat and wrist-strap combination.
- Conductive floor-mat and heel-strap combination.

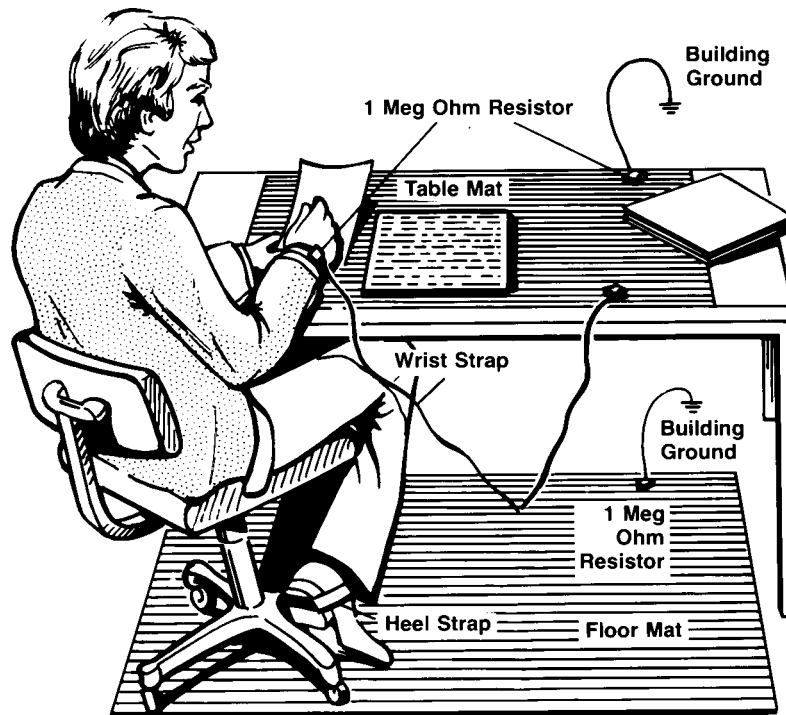

Both types, when used together, provide a significant level of ESD protection. Of the two, only the table-mat and wrist-strap combination provides adequate ESD protection when used alone.

To ensure user safety, the static-safe accessories must provide at least 1 M $\Omega$  of isolation from ground. Refer to [Table 13 on page 5-31](#) for information on ordering static-safe accessories.

---

**WARNING**

---

**These techniques for a static-safe work station should not be used when working on circuitry with a voltage potential greater than 500 volts.**

---

## Reducing ESD Damage

The following suggestions may help reduce ESD damage that occurs during testing and servicing operations.

- Personnel should be grounded with a resistor-isolated wrist strap before removing any assembly from the unit.
- Be sure all instruments are properly earth-grounded to prevent a buildup of static charge.

**Table 13. Static-Safe Accessories**

| <b>Agilent Part Number</b> | <b>Description</b>  |
|----------------------------|---|
| 9300-0797                  | Set includes: 3M static control mat 0.6 m $\times$ 1.2 m (2 ft $\times$ 4 ft) and 4.6 cm (15 ft) ground wire. (The wrist-strap and wrist-strap cord are not included. They must be ordered separately.) |
| 9300-0980                  | Wrist-strap cord 1.5 m (5 ft)   |
| 9300-1383                  | Wrist-strap, color black, stainless steel, without cord, has four adjustable links and a 7 mm post-type connection.   |
| 9300-1169                  | ESD heel-strap (reusable 6 to 12 months).   |

---

## Returning the Instrument for Service

The instructions in this section show you how to properly return the instrument for repair or calibration. Always call the Agilent Technologies Instrument Support Center first to initiate service *before* returning your instrument to a service office. This ensures that the repair (or calibration) can be properly tracked and that your instrument will be returned to you as quickly as possible. Call this number regardless of where you are located. Refer to “Agilent Technologies Service Offices” on page 5-35 for a list of service offices.

Agilent Technologies Instrument Support Center . . . . . (800) 403-0801

If the instrument is still under warranty or is covered by an Agilent Technologies maintenance contract, it will be repaired under the terms of the warranty or contract (the warranty is at the front of this manual). If the instrument is no longer under warranty or is not covered by an Agilent Technologies maintenance plan, Agilent Technologies will notify you of the cost of the repair after examining the unit.

When an instrument is returned to a Agilent Technologies service office for servicing, it must be adequately packaged and have a complete description of the failure symptoms attached. When describing the failure, please be as specific as possible about the nature of the problem. Include copies of additional failure information (such as the instrument failure settings, data related to instrument failure, and error messages) along with the instrument being returned.

---

## Preparing the instrument for shipping

- 1 Write a complete description of the failure and attach it to the instrument. Include any specific performance details related to the problem. The following

information should be returned with the instrument.

- Type of service required.
  - Date instrument was returned for repair.
  - Description of the problem:
    - Whether problem is constant or intermittent.
    - Whether instrument is temperature-sensitive.
    - Whether instrument is vibration-sensitive.
    - Instrument settings required to reproduce the problem.
    - Performance data.
  - Company name and return address.
  - Name and phone number of technical contact person.
  - Model number of returned instrument.
  - Full serial number of returned instrument.
  - List of any accessories returned with instrument.
- 2** Cover all front or rear-panel connectors that were originally covered when you first received the instrument.

---

**CAUTION**

---

Cover electrical connectors to protect sensitive components from electrostatic damage. Cover optical connectors to protect them from damage due to physical contact or dust.

---

**CAUTION**

---

Instrument damage can result from using packaging materials other than the original materials. Never use styrene pellets as packaging material. They do not adequately cushion the instrument or prevent it from shifting in the carton. They may also cause instrument damage by generating static electricity.

- 3** Pack the instrument in the original shipping containers. Original materials are available through any Agilent Technologies office. Or, use the following guidelines:
- Wrap the instrument in antistatic plastic to reduce the possibility of damage caused by electrostatic discharge.
  - For instruments weighing less than 54 kg (120 lb), use a double-walled, corrugated cardboard carton of 159 kg (350 lb) test strength.
  - The carton must be large enough to allow approximately 7 cm (3 inches) on all sides of the instrument for packing material, and strong enough to accommodate the weight of the instrument.
  - Surround the equipment with approximately 7 cm (3 inches) of packing material, to protect the instrument and prevent it from moving in the carton. If packing foam is not available, the best alternative is S.D-240 Air Cap™ from

**Returning the Instrument for Service**

Sealed Air Corporation (Commerce, California 90001). Air Cap looks like a plastic sheet filled with air bubbles. Use the pink (antistatic) Air Cap™ to reduce static electricity. Wrapping the instrument several times in this material will protect the instrument and prevent it from moving in the carton.

- 4** Seal the carton with strong nylon adhesive tape.
- 5** Mark the carton “FRAGILE, HANDLE WITH CARE”.
- 6** Retain copies of all shipping papers.

---

## Agilent Technologies Service Offices

Before returning an instrument for service, call the Agilent Technologies Instrument Support Center at (800) 403-0801, visit the Test and Measurement Web Sites by Country page at <http://www.tm.agilent.com/tmo/country/English/index.html>, or call one of the numbers listed below.

### **Agilent Technologies Service Numbers**

|                          |                  |
|--------------------------|------------------|
| Austria                  | 01/25125-7171    |
| Belgium                  | 32-2-778.37.71   |
| Brazil                   | (11) 7297-8600   |
| China                    | 86 10 6261 3819  |
| Denmark                  | 45 99 12 88      |
| Finland                  | 358-10-855-2360  |
| France                   | 01.69.82.66.66   |
| Germany                  | 0180/524-6330    |
| India                    | 080-34 35788     |
| Italy                    | +39 02 9212 2701 |
| Ireland                  | 01 615 8222      |
| Japan                    | (81)-426-56-7832 |
| Korea                    | 82/2-3770-0419   |
| Mexico                   | (5) 258-4826     |
| Netherlands              | 020-547 6463     |
| Norway                   | 22 73 57 59      |
| Russia                   | +7-095-797-3930  |
| Spain                    | (34/91) 631 1213 |
| Sweden                   | 08-5064 8700     |
| Switzerland              | (01) 735 7200    |
| United Kingdom           | 01 344 366666    |
| United States and Canada | (800) 403-0801   |

Maintenance

**Agilent Technologies Service Offices**



---

# 6

- Step 1. Prepare the site 6-4
- Step 2. Set line voltage selector switch 6-6
- Step 3. Confirm the front and rear-panel connections 6-8
- Step 4. Install the system 6-10
- Step 5. Load correction constants 6-11

---

## Installation

## Installation

The instructions in this chapter show you how to install the Agilent 86037B chromatic dispersion test system. For overseas sales, the product is shipped *without* an ac power connector. You should have a local electrician provide and install an ac connector that meets the standards for the region. Also, be sure to set all instruments to use the local line voltage.

---

**WARNING**

**This CD system is a Safety Class I Product (provided with a protective earthing ground incorporated in the power cord). The mains plug shall only be inserted in a socket outlet provided with a protective earth**

**contact. Any interruption of the protective conductor inside or outside of the product is likely to make the product dangerous. Intentional interruption is prohibited.**

---

**WARNING**

**To prevent electric shock, disconnect the CD system from mains before cleaning. Use a dry cloth or one slightly dampened with water to clean the external case parts. Do not attempt to clean internally.**

---

**WARNING**

**Agilent 83427A: No operator serviceable parts inside. Refer servicing to qualified personnel. To prevent electrical shock, do not remove covers.**

---

**WARNING**

**Agilent 83427A: For continued protection against fire hazard, replace line fuse only with same type and ratings. For 115V operation, use type N 1.0A/250V. For 230V operation, use a 0.75A fuse. The use of other fuses or materials is prohibited.**

---

**WARNING**

**Agilent 86037B and Agilent 83427A: If the system and test set products are not used as specified, the protection provided by the equipment could be impaired. These products must be used in a normal condition (in which all means for protection are intact) only.**

---

**CAUTION**

Agilent 86037B and Agilent 83427A: This system and test set are designed for use in INSTALLATION CATEGORY II and POLLUTION DEGREE 2, per IEC 1010 and 664 respectively.

---

**CAUTION**

Agilent 83427A: Ventilation Requirements. When installing the product in a cabinet, the convection into and out of the product must not be restricted. The ambient temperature (outside the cabinet) must be less than the maximum operating temperature of the product by 4×C for every 100 watts dissipated in the cabinet. If the total power dissipated in the cabinet is greater than 800 watts, then forced convection must be used.

---

**CAUTION**

The warranty and calibration will be voided on systems where the individual instruments, including fiber-optic cables, RF cables, or GPIB cables are removed by the customer. The system should only be disassembled by a Agilent Technologies Customer Engineer. Instruments should not be swapped or removed by non-Agilent Technologies personnel.

---

## Step 1. Prepare the site

Your site should accommodate the dimensions, weights, and power consumption limits shown in the following figure.

---

### **WARNING**

---

**This system weighs approximately 600 lbs (270 kg). To avoid injuries, use proper moving equipment and use extreme care when installing.**

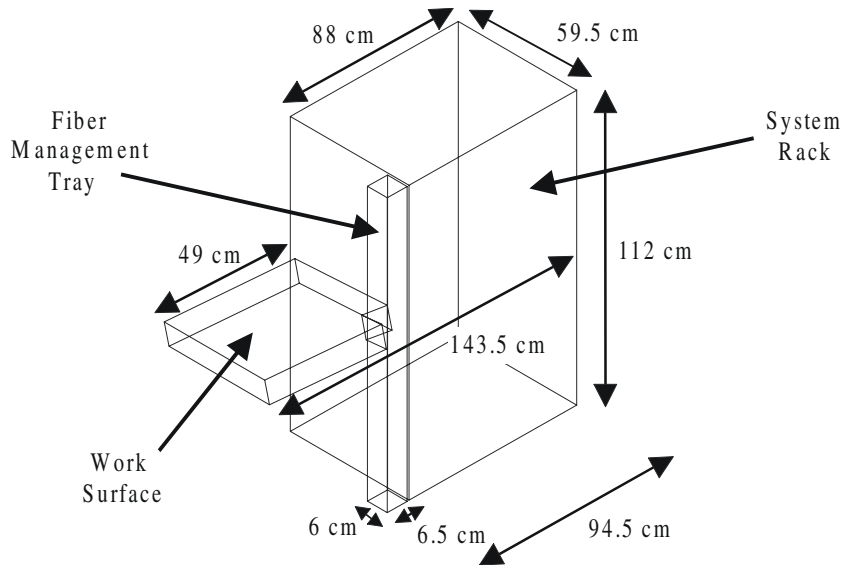

### **System Dimensions**

#### **Assembled Dimensions**

H: 112 cm  
W: 59.5 cm  
D: 143.5 cm

#### **Unassembled Dimensions**

H: 112 cm  
W: 59.5 cm  
D: 94.5 cm

#### **Power Consumption Figures**

Single Band System 594 watts  
Dual Band System 726 watts

#### **Net Weight**

249 kg / 548 lbs.  
269 kg / 592 lbs.

---

**WARNING**

**Install the CD system so that the power cords are readily identifiable and are easily reached by the operator. The power cords are the disconnecting device. They disconnect the mains circuits from the mains supply before other parts of the CD system. Alternately, an externally installed switch or circuit breaker (which is readily identifiable and is easily reached by the operator) may be used as a disconnecting device.**

---

**CAUTION**

Agilent 86037B and Agilent 83427A: Install the system and test set according to the enclosure protection provided. This system and test set do not protect against the ingress of water. The system and test set protects against finger access to hazardous parts within the enclosure.

---

**CAUTION**

Before switching on this system, make sure that the line voltage selector switch on the Agilent 83427A Chromatic Dispersion Test Set's rear panel is set to the voltage of the mains supply, that the correct fuse is installed, and that the supply voltage is in the specified range.

---

## Step 2. Set line voltage selector switch

This diagram shows cabling on an Option 012 dual-band system with Options 113 and 116. For option 114, the wavemeter is removed.

- 1 Make sure that the system is unplugged from the main power supply.
- 2 Confirm that the line voltage selector switch on the Agilent 83427A test set is set to the voltage of the mains supply. The line voltage selector switch is located next to the rear-panel line cord plug. Use a flat blade screwdriver to open the voltage selector door and change the voltage selection tumbler. For 115V operation, use type N 1.0A/250V fuse. For 230V operation, use a 0.75A fuse. A special fuse holder is provided for the 0.75A fuse.

---

### **WARNING**

**Agilent 83427A: The power cord is the disconnecting device. It disconnects the mains circuits from the mains supply before other parts of the instrument. Alternately, an externally installed switch or circuit breaker (which is readily identifiable and is easily reached by the operator) may be used as a disconnecting device. The front panel switch is only a standby switch and is not a LINE switch (disconnecting device).**

---

### **CAUTION**

Agilent 83427A: Always use the three-prong AC power cord supplied with this product. Failure to ensure adequate earth grounding by not using this cord may cause product damage.

---

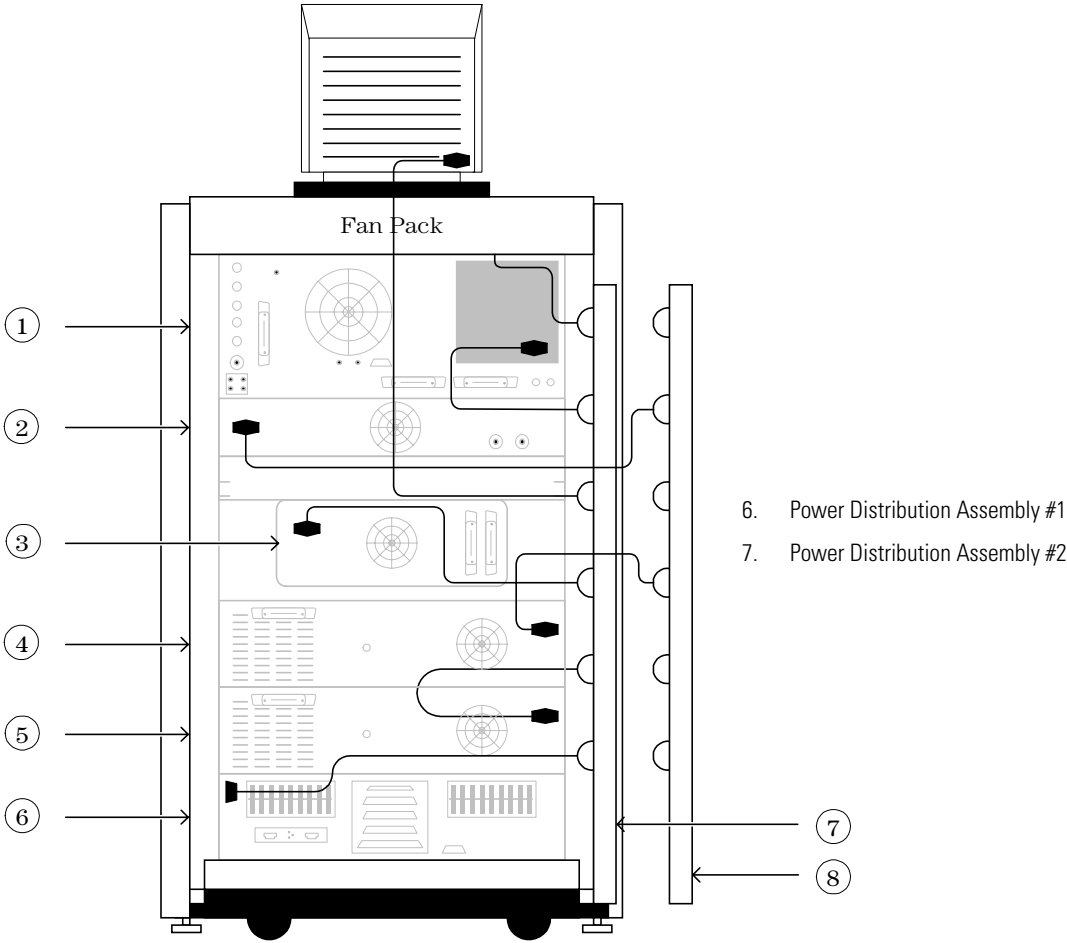

---

### Step 3. Confirm the front and rear-panel connections

This diagram shows cabling on an Option 012 dual-band system with Options 113 and 116. For option 114, the wavemeter is removed.

- The four Agilent 83427A connectors S, R, A, and B should be connected to the identically labeled connectors on the Agilent 8753E RF network analyzer. The WAVELENGTH METER output is connected to the Agilent 86120 wavelength meter, and the TUNABLE LASER SOURCE input is connected to the tunable laser.



- 1. Network Analyzer
- 2. Chromatic Dispersion Test Set
- 3. Agilent 86120B Wavelength meter
- 4. Tunable Laser Source #1
- 5. Tunable Laser Source #2
- 6. HP Personal Computer

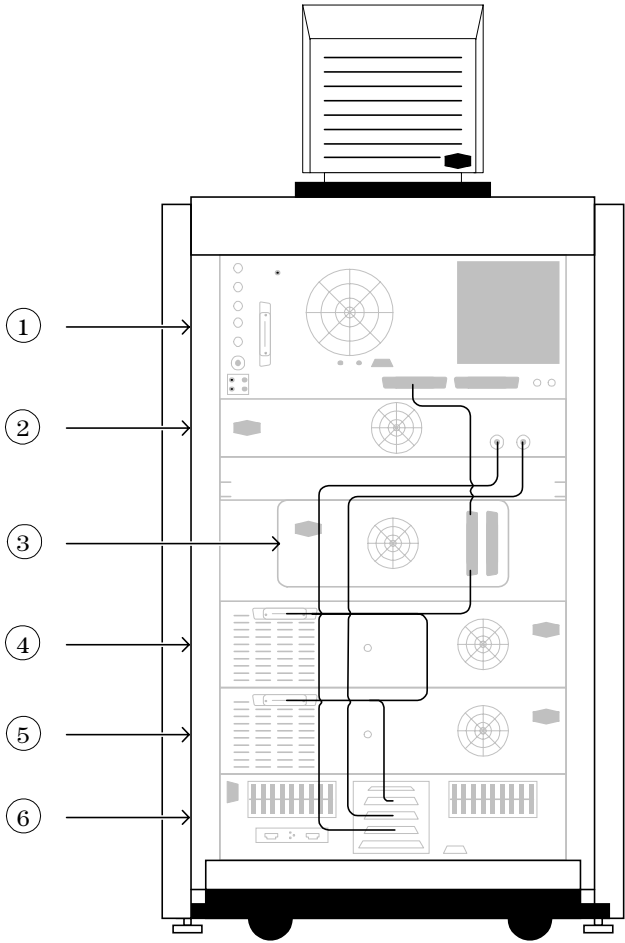

---

## Step 4. Install the system

- 1 Remove the tape securing a fibers to the outside of the fiber management tray housing.
- 2 Remove the protective cover, and clean the fiber-optic connector.

Before making the fiber-optic connections, refer to “Cleaning Connections for Accurate Measurements” on page 5-20.

- 3 Connect the fiber-optic cables to their proper locations. Labels located on each fiber identify the correct connection. [Table 6-1](#) also lists the connections for each fiber-optic cable.

---

### CAUTION

The cables should be as straight as possible to avoid damage to the cable and poor readings at the instrument.

**Table 6-1. Fiber Cable Connections**

| From             | To       | Fiber Type   |
|------------------|----------|--|
| TLS              | Test Set | Polarization-Maintaining Fiber (PMF) cable. (Blue fiber with black strain-relief boots on both ends) |
| Wavelength Meter | Test Set | Normal Single-Mode Fiber Cable   |

- 4 Install the keyboard holder under the work top.
- 5 Install the keyboard in the keyboard tray, and run the keyboard cable to the personal computer.
- 6 Connect the mouse to the personal computer.
- 7 Connect the video cable from the display to the personal computer.
- 8 Connect the display’s power cord to the personal computer.
- 9 Plug in the Power Distribution Units (PDU).
- 10 Turn on the system, and allow it to warm up for two hours.
- 11 Click on the Agilent 86037B chromatic dispersion test system icon located on the Windows desktop. A splash screen will appear displaying the software title followed by the application screen shown in the following figure.



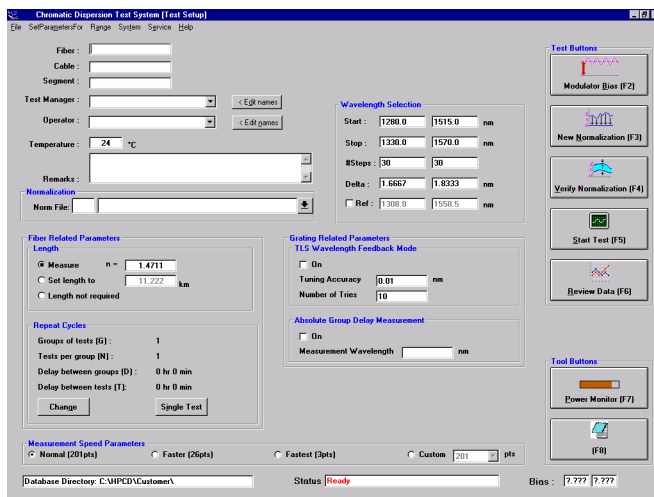

## Step 5. Load correction constants

- 1 Create correction constants for the tunable laser source. Refer to “Normalizing the Laser” on page 3-8.
- 2 Create correction constants for the power monitor. Refer to “Adjusting the Power Monitor” on page 3-10.



|  |      |
|--|------|
| Theory of Operation                        | 7-2  |
| Rack Diagram                               | 7-6  |
| Chromatic Dispersion—theory and management | 7-8  |
| Measurement Repeatability                  | 7-11 |
| Material Lists                             | 7-13 |
| Power Cords                                | 7-16 |
| System Options                             | 7-17 |

---

## Reference

## Theory of Operation

The Agilent 86037B uses the modulation phase-shift measurement technique for performing near-end measurements, where there is access to both fiber ends at the same location. A diagram of a measurement apparatus based on the modulation phase-shift technique is shown in Figure 7-1. This system is most useful in fiber, grating and cable manufacturing, as well as for testbed evaluation and system manufacturing.

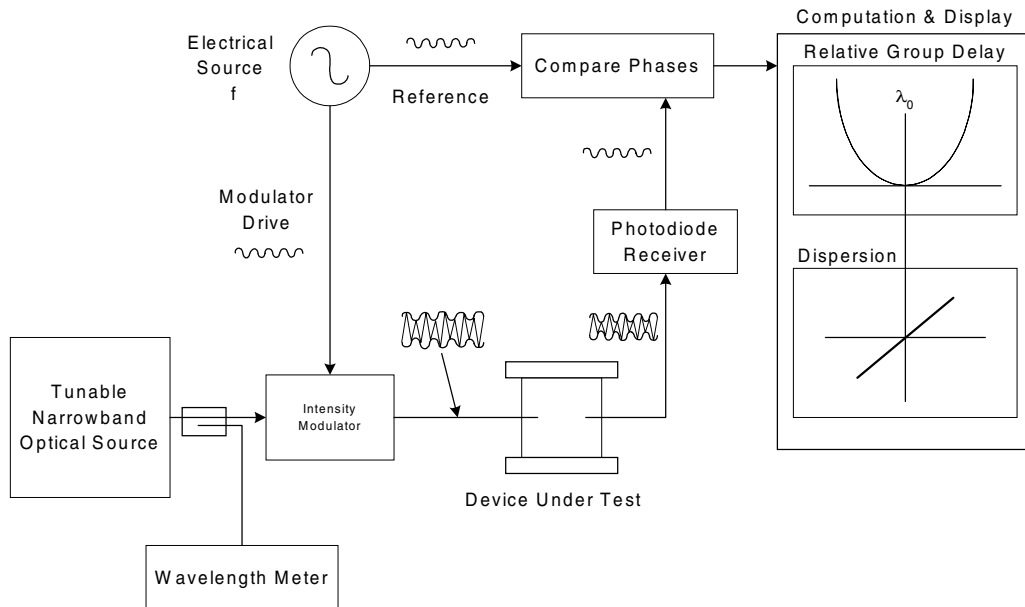

**Figure 7-1. Measurement of chromatic dispersion using the phase-shift method**

Figure 7-2 through Figure 7-4 show three block diagrams of the most common system options. There are several other options which are discussed later in this chapter. The RF source of an Agilent 8753 RF network analyzer drives an

optical modulator which modulates the lightwave signal from a tunable laser at a frequency of up to 2.5 GHz. A polarization-maintaining fiber connects the tunable laser to the modulator to maintain a stable modulation index. This modulated lightwave signal passes through the device under test, is detected and converted back into a RF signal by an optical-to-electrical converter.

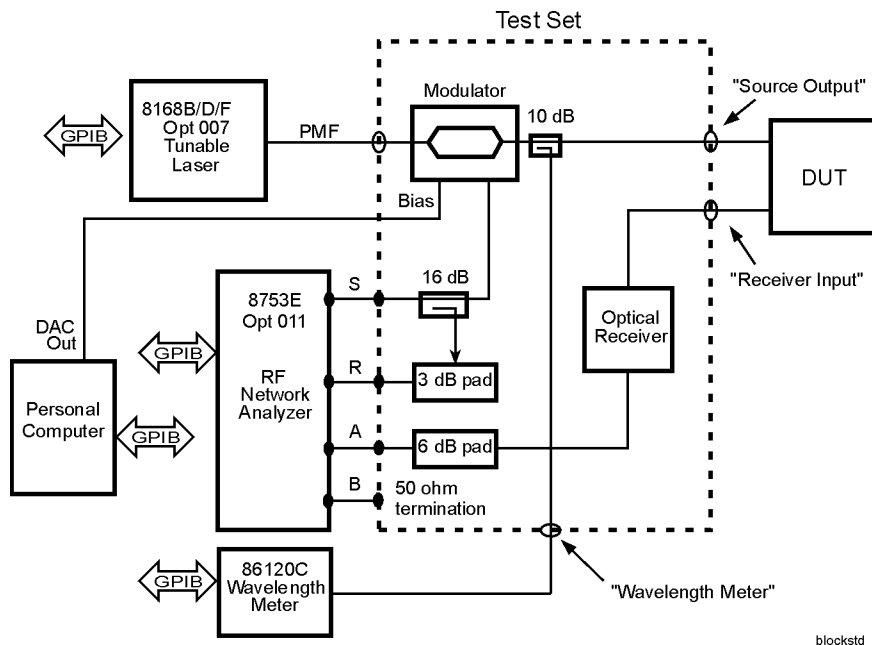
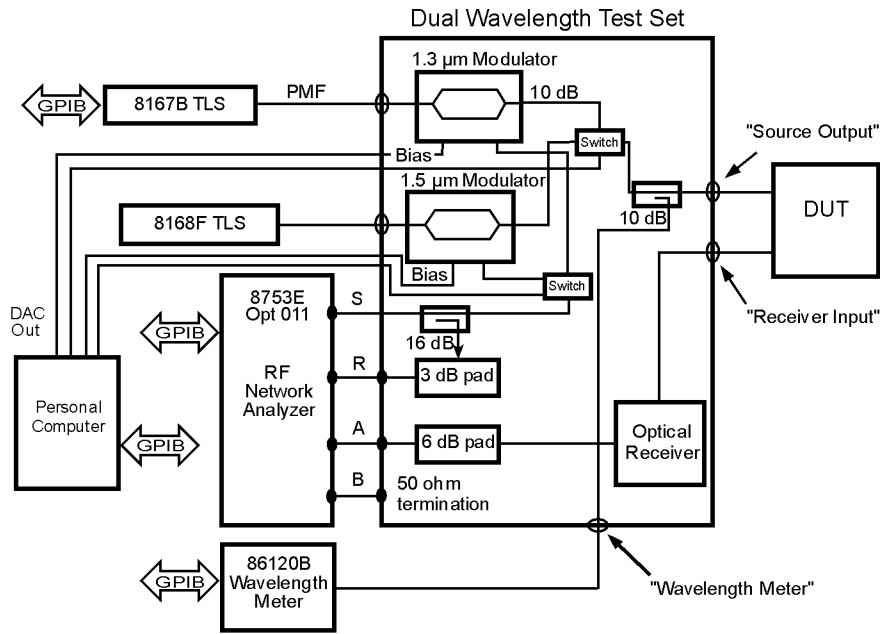

**Figure 7-2. Agilent 86037B Block Diagram (standard and Options 111, 112, 113, 114)**

The Agilent 8753 RF network analyzer measures the shift in phase of the RF signal by comparing it to a reference derived from the signal driving the modulator. The measured phase is numerically converted into a value for group delay. By tuning the wavelength of the laser, we obtain group delay as a function of wavelength and, after data processing, the dispersion of the device under test. Increased wavelength accuracy is made possible by an external wavelength meter which automatically measures and provides feedback on the wavelength as the laser tunes. The wavelength meter may be supplied by the user.

The Agilent 83427A chromatic dispersion test set contains an instrument grade receiver and modulator to ensure a stable and accurate recovery of the optical signal. This test set was designed to be part of the Agilent 86037B.

**Theory of Operation**



block112

**Figure 7-3. Agilent 86037B Block Diagram (Options 121 and 122)**



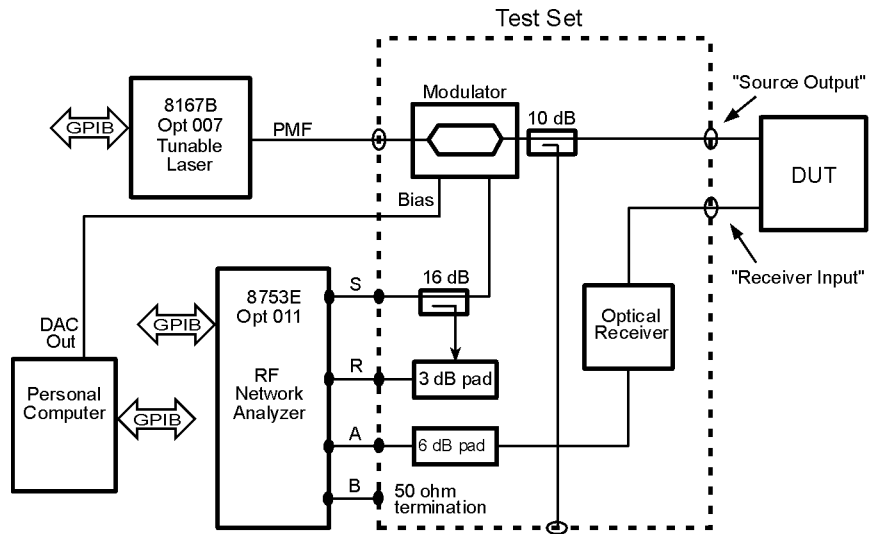

block113.cdr

**Figure 7-4. The Agilent 86037B Option 114 block diagram**

## Rack Diagram

This figure shows the dual-band system (Option 112). A single-band system such as the standard system, Option 113, Option 114, or Option 116, will not contain item ⑦, the second tunable laser source.

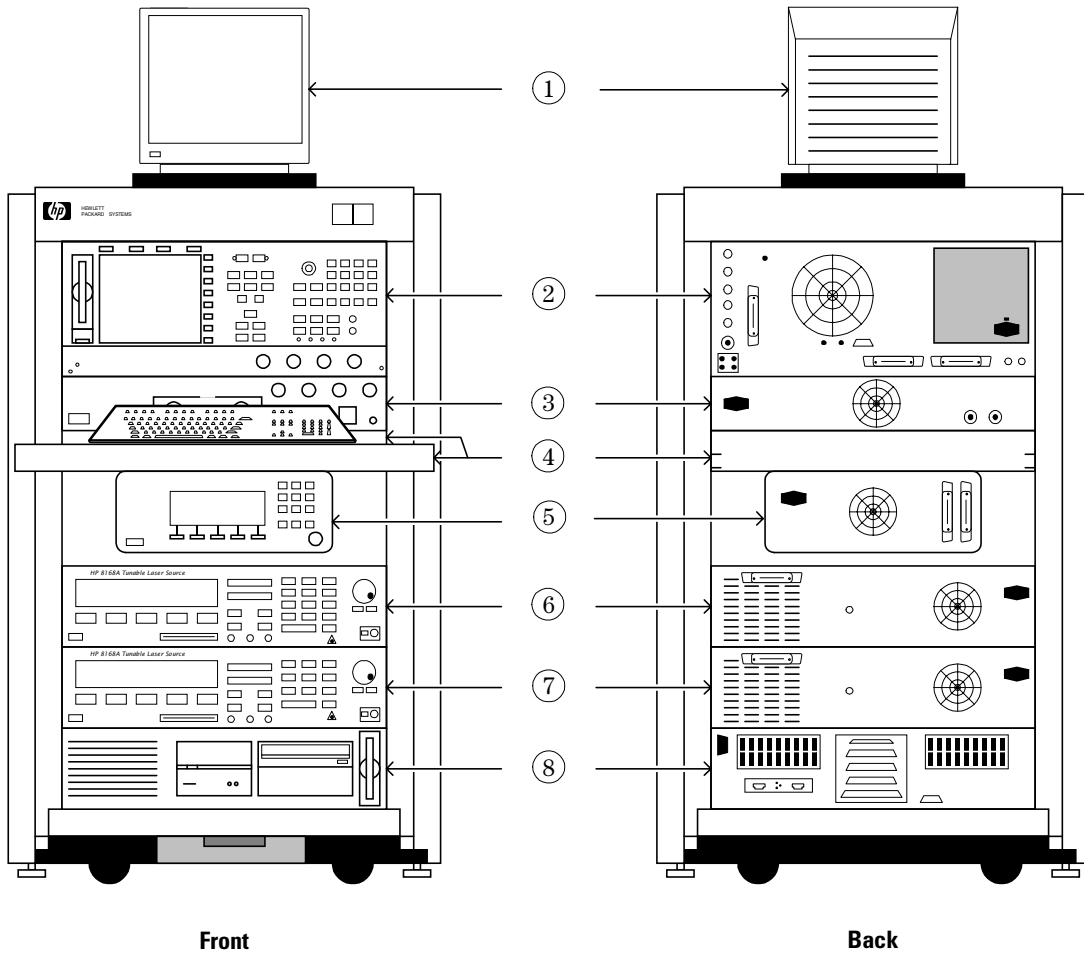

**Figure 7-5. Rack Diagram (Front View)**

- ① Display
- ② Network Analyzer
- ③ Chromatic Dispersion Test Set
- ④ Work surface / Modified Filler Panel
- ⑤ Wavelength meter
- ⑥ Tunable Laser Source #1
- ⑦ Tunable Laser Source #2
- ⑧ Personal Computer

**Table 7-1. Instrument Power Requirements**

| <b>Component</b>                    | <b>Maximum Volts AC</b>                |
|-------------------------------------|--|
| Agilent 8753x Network Analyzer      | 280                                    |
| Agilent 83427A CD Test Set          | 110 VA MAX (115v)<br>150 VA MAX (220v) |
| Agilent 86120x Wavelength meter     | 110 (115v)<br>150 (220v)               |
| Agilent 8168x or 8167x TLS #1       | 260                                    |
| Agilent 8168x or 8167x TLS #1       | 260                                    |
| Personal Computer                   | 110 (115v)<br>150 (220v)               |
| PDU AW3 (110V) or PDU AW5 (220V) #1 | 110 (115v)<br>150 (220v)               |
| PDU AW3 (110V) or PDU AW5 (220V) #2 | 110 (115v)<br>150 (220v)               |

---

## Chromatic Dispersion—theory and management

Chromatic dispersion results from a variation in propagation delay with wavelength that is shaped, in turn, by the interplay of fiber materials and dimensions. The result is that different frequencies of light travel down optical fiber at different speeds. The optical source in a high-speed communication system is typically a single-line diode laser with a nonzero spectral width. Pulse modulation increases the spectral width.

Signal dispersion is a factor in fiber-optic systems. As more information is sent on a wider frequency bandwidth, and for greater distances, the importance of signal dispersion will become greater.

Each wavelength component of the signal travels at a slightly different speed, resulting in the pulse broadening illustrated in [Figure 7-6](#).

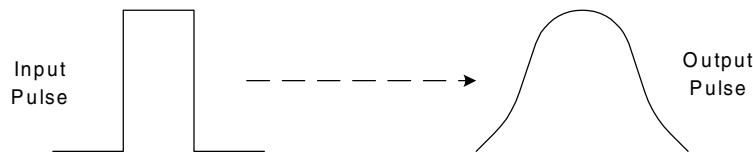

**Figure 7-6. Dispersion Effect on a Transmitted Pulse**

Chromatic dispersion is the primary dispersive mechanism in singlemode fiber. In singlemode fiber, chromatic dispersion results from the interplay of the following two underlying effects:

- Material dispersion results from the dependence upon wavelength of the refractive index (and the corresponding group velocity) of doped silica.
- Waveguide dispersion is rooted in the wavelength-dependent relationships of the group velocity to the core diameter and the difference in index between the core and the cladding.

A third component, called second-order PMD (polarization-mode dispersion) or differential group delay dispersion, arises because the velocity of propagation depends on the polarization state of the lightwave signal. The PMD of the

fiber-optic cable is not constant over time, making compensation difficult. This effect will ultimately limit the highest achievable data rates for a single-wavelength fiber optic system.

### ***Managing chromatic dispersion***

Control of the total chromatic dispersion of transmission paths is critical to the design and construction of long-haul, high-speed telecommunications systems. The first objective is to reduce the total dispersion to the point where its contribution to the error rate of the system is acceptable. A system consists of many spans of fiber from different manufacturing runs, each with its own zero-dispersion wavelength and dispersion slope at  $\lambda_0$  (lambda-zero). The dispersion of a single-channel system can be controlled by connecting fibers of differing dispersion such that the total dispersion is near zero. Alternately, dispersion may be allowed to accumulate along the path and then compensated at the output of the system. For example, if an installed dispersion-shifted fiber system exhibits negative dispersion at the chosen operating wavelength, it can be compensated with a relatively short length of dispersion-unshifted fiber, which has a large, positive dispersion coefficient at the same wavelength. Dispersion can also be compensated with chirped fiber Bragg gratings, made by exposing specially doped fiber to an interference pattern of intense ultraviolet light. Chirping refers to an increase in the period of the index variation as a function of distance along the fiber. Dispersion compensation is more complex in dense WDM (wavelength division multiplexing) systems.

The output power of erbium-doped fiber amplifiers (EDFA's) is sufficient to produce nonlinear effects in singlemode fiber. The second objective of chromatic dispersion compensation is to limit the impairments caused by these nonlinearities. For example, four-wave mixing can be controlled by maintaining a small negative dispersion in those portions of a span that are exposed to high power levels. (Another approach to this problem, in wavelength multiplexed systems, is to space channels in unequal wavelength increments).

### ***Summary***

In high-speed, long-haul systems, chromatic dispersion must be compensated for to minimize ordinary pulse broadening. Some chromatic dispersion must be maintained at a small but non-zero level in regions where the optical power is extremely high.

Chromatic dispersion measurements are performed by fiber and cable researchers, manufacturers, and system integrators. Increasingly, chromatic dispersion measurements are also performed during the design, manufacture, and incoming inspection of system components, particularly chromatic disper-

**Chromatic Dispersion—theory and management**

sion compensators and wavelength division multiplexing components. In the field, chromatic dispersion is measured in connection with the installation of new systems or the upgrade of existing routes to higher bit rates. Some types of measurement systems require local access to both ends of the test fiber, making them more appropriate for factory and laboratory testing and special cases in which it is practical to measure installed fiber in a loop-back arrangement.

---

## Measurement Repeatability

This section compares the measurement repeatability of Agilent 86037B with and without the multi-wavelength meter. The measurements were performed on the same spool of 22-km dispersion-shifted fiber. The wavelength range was from 1525 nm to 1575 nm in 1 qnm steps. The data were analyzed with the five-term Sellmeier fit.

The standard deviation for  $\lambda_0$  is actually higher for the measurements taken with the multi-wavelength meter than for those without. This is most likely because the measurements made with the multi-wavelength meter take longer, and therefore are more susceptible to fiber length drifts. The particular Agilent Technologies tunable laser source used in the measurement was so accurate that it did not introduce much wavelength error. These results are based on one system, therefore we cannot guarantee them as specifications for all systems since the absolute wavelength accuracy of Agilent Technologies' tunable laser sources is specified to be  $\pm 0.1$  nm. For best accuracy, a system with a multi-wavelength meter is still recommended.

**Table 7-2. Repeatability Data for 20 Runs With the Multi-Wavelength Meter**

| Parameter          | $\lambda_0$ (nm) | $S_0$ [ps/ (nm <sup>2</sup> × km)] |
|--------------------|------------------|------------------------------------|
| Mean               | 1550.8938        | 0.0733825                          |
| Maximum            | 1550.9062        | 0.0734366                          |
| Minimum            | 1550.8829        | 0.0733237                          |
| Max-min            | 0.0233           | 0.0001129                          |
| Standard Deviation | 0.008116         | 0.0000318                          |

**Measurement Repeatability****Table 7-3. Repeatability Data for 20 Runs Without the Multi-Wavelength Meter**

| <b>Parameter</b>   | <b><math>\lambda_0</math> (nm)</b> | <b><math>S_0</math> [ps/ (nm<sup>2</sup> × km)]</b> |
|--------------------|------------------------------------|---|
| Mean               | 1550.8850                          | 0.0733461   |
| Maximum            | 1550.8906                          | 0.0734181   |
| Minimum            | 1550.8789                          | 0.0732212   |
| Max-min            | 0.0117                             | 0.0001969   |
| Standard Deviation | 0.00354                            | 0.0000553   |

**Table 7-4. Comparison Between the Mean Values**

| <b>Parameter</b>         | <b>Mean <math>\lambda_0</math> (nm)</b> | <b>Mean <math>S_0</math> [ps/ (nm<sup>2</sup> × km)]</b> |
|--------------------------|---|--|
| With wavelength meter    | 1550.8850                               | 0.0733461  |
| Without wavelength meter | 1550.8938                               | 0.0733875  |
| $\Delta$                 | 0.0088                                  | 0.0000364  |



---

## Material Lists

**Table 7-5. Standard System Material List (1 of 2)**

| <b>Description</b>    | <b>Part Number</b> | <b>Quantity</b> |
|-----------------------|--------------------|-----------------|
| SMM5.0 10 CWPNTX      | 0515-0386          | 4               |
| SM 1032 CWPNPH        | 0570-1366          | 22              |
| FC/PC CONNECTOR       | 08154-61702        | 1               |
| BOARD-DAC CONN        | 0960-0988          | 1               |
| ADPT-FBR OPT. SM      | 1005-0089          | 1               |
| CBL FBR SPC 1.75M     | 1005-0172          | 1               |
| CBL FBR SPC .40       | 1005-0173          | 1               |
| CBL FBR SPC SPC 1.25M | 1005-0177          | 1               |
| CA FBROPT FC/PC       | 1005-0384          | 1               |
| FO VERI SPOOL         | 1005-0387          | 1               |
| OPT FIBER 1310NM      | 1005-0421          | 1               |
| CONN PWR M 5-15       | 1251-4218          | 1               |
| CAP-PROT .812ID       | 1401-0247          | 13              |
| CAP-COND .612ID       | 1401-0247          | 13              |
| SM1032 5CWPNTX        | 2680-0278          | 31              |
| 1U BLANK              | 40101A             | 1               |
| RK FLR PNL-5.25       | 40103A             | 1               |
| WORK SURFACE AY       | 46298N             | 1               |
| GPIB CABLE ADAP       | 5060-9462          | 2               |
| KIT-RACK MT FLAG      | 5062-3974          | 1               |
| RACK MT FLG           | 5062-3974          | 1               |
| RCK MNT KIT           | 5062-3977          | 1               |
| RK MOUNT KIT          | 5062-3979          | 1               |
| RACK FLANGE KIT       | 5062-6450          | 1               |
| CA 03C 03F-03M        | 8120-1405          | 3               |
| CA BNC/BNC 48C        | 8120-2582          | 1               |
| CA 24C 24F-24F        | 8120-3444          | 1               |
| CA 24C 24F-24F        | 8120-3445          | 2               |

**Material Lists****Table 7-5. Standard System Material List (2 of 2)**





| <b>Description</b>   | <b>Part Number</b> | <b>Quantity</b> |
|--|--------------------|-----------------|
| CBL M-N M-N7.5IN   | 8120-4782          | 4               |
| PWR CRD 0  | 8120-5178          | 1               |
| TNBL LSR SRCE  | 8167B              | 0               |
| TNBL LSR SRCE  | 8168D              | 0               |
| TNBL LSR SRCE  | 8168E              | 0               |
| TNBL LSR SRCE + OD   | 8168E OPT 007      | 1               |
| TNBL LSR SRCE  | 8168F              | 1               |
| GPIB INTFC BD  | 82335B             | 1               |
| RFCA AY-OPSW OUT   | 83427-60003        | 0               |
| MOD BIAS CA-OUT  | 83427-60001        | 0               |
| CHROM DISP-TS  | 83427A             | 1               |
| BRKT KEYBD HLDR  | 83467-00005        | 1               |
| COVER-RIGHT  | 83467-00016        | 1               |
| SOFTWARE-CD  | 83467-10001        | 1               |
| FIBER MNGMT TRAY   | 83467-60001        | 1               |
| DAC TO BNC ADPTR   | 83467-60002        | 1               |
| USER GDE-86037A  | 86037-90001        | 1               |
| SERV GDE-86037A  | 86037-90002        | 1               |
| OPT MLT-VW METER OPT. UK6  | 86120B             | 1               |
| RF NTWK ANALYZER OPT. 011 & OPT. UK6                                 | 8753E              | 1               |
| MOUSEPAD 11.5x9  | 9300-1498          | 1               |
| FAN ASSY 110 V   | C2786-60024        | 1               |
| HP ULTRA VGA1024 OPT ABA   | D2825A             | 1               |
| CD ROM DRIVE   | D4383B             | 1               |
| 32MB SDRAM DIMM  | D5362A             | 1               |
| VECTRA VL  | D5721N             | 1               |
| LAN CARD   | D6692A             | 1               |
| 1100 MM EIA 19IN AW3 (FOR 110 V)<br>1100 MM EIA 19IN AW5 9for 220 V) | 33660A             | 1               |
| RAIL   | E3663-00001        | 6               |

**Table 7-6. Option 112 Material List**

| <b>Description</b>   | <b>Part Number</b> | <b>Quantity</b> |
|--|--------------------|-----------------|
| RACK FLANGE KIT  | 5062-6450          | 1               |
| CA 03C 03F-03M   | 8120-1405          | 3               |
| CA BNC/BNC 48C   | 8120-2582          | 1               |
| CA 24C 24F-24F   | 8120-3444          | 1               |
| CA 24C 24F-24F   | 8120-3445          | 2               |
| CBL M-N M-N7.5IN   | 8120-4782          | 4               |
| PWR CRD 0  | 8120-5178          | 1               |
| TNBL LSR SRCE  | 8167B              | 0               |
| TNBL LSR SRCE  | 8168D              | 0               |
| TNBL LSR SRCE  | 8168E              | 0               |
| TNBL LSR SRCE + OD   | 8168E OPT 007      | 1               |
| TNBL LSR SRCE  | 8168F              | 1               |
| GPIB INTFC BD  | 82335B             | 1               |
| RFCA AY-OPSW OUT   | 83427-60003        | 0               |
| MOD BIAS CA-OUT  | 83427-60001        | 0               |
| CHROM DISP-TS  | 83427A             | 1               |
| BRKT KEYBD HLDR  | 83467-00005        | 1               |
| COVER-RIGHT  | 83467-00016        | 1               |
| SOFTWARE-CD  | 83467-10001        | 1               |
| FIBER MNGMT TRAY   | 83467-60001        | 1               |
| DAC TO BNC ADPTR   | 83467-60002        | 1               |
| USER GDE-86037A  | 86037-90001        | 1               |
| SERV GDE-86037A  | 86037-90002        | 1               |
| OPT MLT-WV METER OPT. UK6  | 86120B             | 1               |
| RF NTWK ANALYZER OPT. 011 & OPT. UK6                                 | 8753E              | 1               |
| MOUSEPAD 11.5x9  | 9300-1498          | 1               |
| FAN ASSY 110 V   | C2786-60024        | 1               |
| HP ULTRA VGA1024 OPT ABA   | D2825A             | 1               |
| CD ROM DRIVE   | D4383B             | 1               |
| 32MB SDRAM DIMM  | D5362A             | 1               |
| VECTRA VL  | D5721N             | 1               |
| LAN CARD   | D6692A             | 1               |
| 1100 MM EIA 19IN AW3 (FOR 110 V)<br>1100 MM EIA 19IN AW5 9for 220 V) | 33660A             | 1               |
| RAIL   | E3663-00001        | 6               |

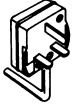
Reference  
**Power Cords**

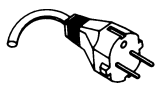
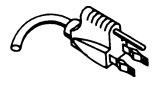
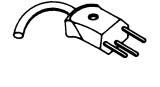
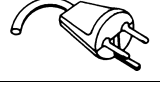
## Power Cords

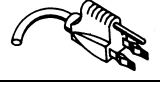
| Plug Type   | Cable Part No. | Plug Description         | Length (in/cm) | Color      | Country   |
|---|----------------|--------------------------|----------------|------------|---|
| 250V<br>   | 8120-1351      | Straight *BS1363A        | 90/228         | Gray       | United Kingdom, Cyprus, Nigeria, Zimbabwe, Singapore                                |
|   | 8120-1703      | 90°                      | 90/228         | Mint Gray  |   |
| 250V<br>   | 8120-1369      | Straight *NZSS198/ASC    | 79/200         | Gray       | Australia, New Zealand  |
|   | 8120-0696      | 90°                      | 87/221         | Mint Gray  |   |
| 250V<br>   | 8120-1689      | Straight *CEE7-Y11       | 79/200         | Mint Gray  | East and West Europe, Saudi Arabia, So. Africa, India (unpolarized in many nations) |
|   | 8120-1692      | 90°                      | 79/200         | Mint Gray  |   |
|   | 8120-2857      | Straight (Shielded)      | 79/200         | Coco Brown |   |
| 125V<br>   | 8120-1378      | Straight *NEMA5-15P      | 90/228         | Jade Gray  | United States, Canada, Mexico, Philippines, Taiwan                                  |
|   | 8120-1521      | 90°                      | 90/228         | Jade Gray  |   |
|   | 8120-1992      | Straight (Medical) UL544 | 96/244         | Black      |   |
| 250V<br>  | 8120-2104      | Straight *SEV1011        | 79/200         | Mint Gray  | Switzerland   |
|   | 8120-2296      | 1959-24507 Type 12 90°   | 79/200         | Mint Gray  |   |
| 220V<br> | 8120-2956      | Straight *DHCK107        | 79/200         | Mint Gray  | Denmark   |
|   | 8120-2957      | 90°                      | 79/200         | Mint Gray  |   |
| 250V<br> | 8120-4211      | Straight SABS164         | 79/200         | Jade Gray  | Republic of South Africa<br>India   |
|   | 8120-4600      | 90°                      | 79/200         |            |   |
| 100V<br> | 8120-4753      | Straight MITI            | 90/230         | Dark Gray  | Japan   |
|   | 8120-4754      | 90°                      | 90/230         |            |   |

\* Part number shown for plug is the industry identifier for the plug only. Number shown for cable is the Agilent Technologies part number for the complete cable including the plug.

---

## System Options

### Agilent 86037B Options

| Option  | Change from Standard System   |
|---|---|
| Standard  | Agilent 8753E #011 Network Analyzer<br>PC Controller<br>E3660A Rack   |
| Option 111<br>1550 nm Configuration               | Add Agilent 8168F #007 #021 TLS<br>Add Agilent 86120C multi-wavelength meter<br>Add Agilent 83427A test set   |
| Option 112<br>1600nm Configuration                | Add Agilent 8168F #503 #007 #021 TLS<br>Add Agilent 86120C multi-wavelength meter<br>Add Agilent 83427A test set  |
| Option 113<br>1300nm Configuration                | Add Agilent 8167B #007 #021 TLS<br>Add Agilent 86120C multi-wavelength meter<br>Add Agilent 83427A test set   |
| Option 114<br>Economical 1550nm Configuration     | Add Agilent 8168D #007 #021 TLS<br>Add Agilent 83427A test set  |
| Option 121<br>1300/1550nm Dual Band Configuration | Add Agilent 8168F #007 #021 TLS<br>Add Agilent 8167B #007 #021 TLS<br>Add Agilent 86120C multi-wavelength meter<br>Add Agilent 83427A dual band test set      |
| Option 122<br>1300/1600nm Dual Band Configuration | Add Agilent 8168F #503 #007 #021 TLS<br>Add Agilent 8167B #007 #021 TLS<br>Add Agilent 86120C multi-wavelength meter<br>Add Agilent 83427A dual band test set |



Specifications 8-3

Regulatory Information 8-7

---

## Specifications and Regulatory Information

# Specifications and Regulatory Information

This chapter lists specifications and characteristics of the Agilent 86037B. Specifications apply over the temperature range  $+23^{\circ}\text{C} \pm 3^{\circ}\text{C}$  after the system's temperature has been stabilized after two hours of continuous operation.

- Specifications**      *Specifications* described warranted performance.
- Characteristics**      *Characteristics* provide useful, nonwarranted, information about the functions and performance of the system. *Characteristics are printed in italics.*
- Calibration cycle**      Agilent Technologies warrants instrument specifications over the recommended calibration interval. To maintain specifications, periodic recalibrations are necessary. We recommend that the Agilent 86037B be calibrated at an Agilent Technologies service facility every 24 months.



---

## Specifications

**Table 8-1. Chromatic Dispersion Measurement Specifications**

| Measurement   | Specification  |
|---|--|
| Wavelength Resolution                                       | 1 pm with Agilent 8168F/Agilent 8167B tunable laser source<br>0.1 nm with Agilent 8168D tunable laser source             |
| Wavelength Accuracy   | 0.003 nm with multi-wavelength meter<br>0.1 nm without multi-wavelength meter (except Option 114)<br>0.2 nm (Option 114) |
| Wavelength Range:   |  |
| Option 111 (standard)                                       | 1450 – 1590 nm   |
| Option 112 (1600 nm)  | 1510 – 1640 nm   |
| Option 113 (1300 nm)  | 1255 – 1365 nm   |
| Option 114 (1500 nm)  | 1490 – 1565 nm   |
| Option 121 (1300/1550 nm)                                   | 1255 – 1365 nm, and 1450 – 1590 nm   |
| Option 122 (1300/1600 nm)                                   | 1255 – 1365 nm, and 1510 – 1640 nm   |
| Maximum optical power from SOURCE OUTPUT <sup>a</sup>       |  |
| Option 111 (standard)                                       | –1 dBm, 1520 – 1570 nm   |
| Option 112  | –2 dBm, 1545 – 1620 nm   |
| Option 113  | –5 dBm, 1310 – 1350 nm   |
| Option 114  | –12 dBm, 1500 – 1565 nm  |
| Option 121  | –5 dBm, 1310 – 1350 nm<br>–1 dBm, 1520 – 1570 nm   |
| Option 122  | –5 dBm, 1310 – 1350 nm<br>–2 dBm, 1545 – 1620 nm   |
| System Dynamic Range ( <i>characteristic</i> ) <sup>b</sup> |  |
| Option 111 (standard)                                       | –40 dB optical, 1520 – 1570 nm   |
| Option 112  | –39 dB optical, 1545 – 1620 nm   |
| Option 113  | –40 dB optical, 1310 – 1350 nm   |
| Option 114  | –30 dB optical, 1500 – 1565 nm   |
| Option 121  | –40 dB optical, 1310 – 1350 nm<br>–40 dB optical, 1520 – 1570 nm   |
| Option 122  | –40 dB optical, 1310 – 1350 nm<br>–39 dB optical, 1545 – 1620 nm   |

**Specifications****Table 8-1. Chromatic Dispersion Measurement Specifications (Continued)**

| <b>Measurement</b>   | <b>Specification</b>                                   |
|--|--|
| Optical power range for RECEIVER INPUT   | -3 to -43 dBm (optical)                                |
| Modulation frequency range   | 100 MHz to 2.5 GHz                                     |
| Dispersion measurement range   | 0.1 ps/nm to $D_{max}^c$                               |
| Group delay uncertainty <sup>d</sup>   | 0.5 ps ( <i>0.05 ps characteristic</i> )               |
| <i>Zero dispersion wavelength repeatability<sup>e</sup></i>                        | 0.05 nm ( <i>0.005 nm characteristic</i> )             |
| <i>Repeatability of dispersion slope at zero dispersion wavelength<sup>e</sup></i> | <i>0.002 ps/(nm<sup>2</sup> × km) (characteristic)</i> |
| <i>Zero dispersion wavelength accuracy<sup>f</sup></i>                             |  |
| <i>with wavelength meter (With Agilent 8168F)</i>                                  | <i>±0.05 nm</i>  |
| <i>without wavelength meter (With Agilent 8168F)</i>                               | <i>±0.15 nm</i>  |
| <i>without wavelength meter (With Agilent 8168D)</i>                               | <i>±0.25 nm</i>  |
| <i>Relative amplitude accuracy</i>   | <i>±0.25 dB (characteristic)</i>                       |
| <i>Measurement time (characteristic)<sup>g</sup></i>                               |  |
| with wavelength meter  | 3 seconds per point                                    |
| without wavelength meter   | 2 seconds per point                                    |

- a. Refer to power specification for tunable laser source for other wavelength ranges.
- b. System dynamic range is calculated by subtracting the test set loss and receiver sensitivity from the tunable laser source's output power.
- c. Maximum dispersion,  $D_{max}$  (in ns/nm), is given by  $25/DI$ , where  $DI$  is the wavelength step size in nm.
- d. Based on noise floor measurements, full output power, reference wavelength on, no averaging, and high substitute
- e. One standard deviation for 20 measurements on the same spool of 10 km dispersion-shifted fiber for the wavelength range from 1515 to 1580 nm with power into RECEIVER INPUT at -43 dBm (optical). Parameters refer to curve fit traces using the five-term Sellmeier fit.
- f. These values are based on measurements of NIST Standard Reference Material 2524, Serial No. 0001, using a quadratic fit to 65 point spaced at 1 nm.
- g. This calculation was done for 65 points on a standard spool of 10 km fiber using normal sensitivity. Any change of sensitivity will result in a corresponding change in time. As an example, 10 runs of standard fiber with 65 points per run takes about one hour.

**Length Measurement Specifications**

| <b>Measurement</b>            | <b>Specification</b>   |
|-------------------------------|--|
| Range                         | 0.2 m to 100,000 km (amplified system) <sup>a</sup>                            |
| Range resolution <sup>b</sup> | 0.05 mm or 0.1% of the measured length, whichever is greater. (characteristic) |
| Group refractive index        | 1.0000 – 2.0000 (user adjustable)  |

a. For very long lengths of fibers, the use of EDFA amplifiers is assumed. The system's dynamic range is not sufficient to measure long lengths without amplification.

b. Range resolution is a measure of the ability to pinpoint the peak of a response in the length measurement.

**Calculation Methods**

| <b>Method</b>                                   |
|---|
| <i>Five-term sellmeier fit</i>                  |
| <i>Quadratic fit</i>                            |
| <i>Three-term sellmeier fit</i>                 |
| <i>Direct calculation from group delay data</i> |

**Multi-Wavelength Meter Characteristics**

| <b>Measurement</b>         | <b>Specification</b>     |
|----------------------------|--------------------------|
| <i>Wavelength accuracy</i> | $\pm 0.003$ nm           |
| <i>Input Power Range</i>   | -40 to +10 dBm (optical) |

**Specifications****General System Characteristics**

| <b>Use</b>                       | <b>Specification</b>   |
|----------------------------------|--|
| <i>Use</i>                       | <i>indoor</i>  |
| <i>Altitude</i>                  | <i>Up to 15,000 feet (4,572 meters)</i>  |
| <i>Non-operating temperature</i> | <i>-40° C to 70° C</i>   |
| <i>Power Requirements</i>        | <i>110, 120, 220, or 240 VAC ±10%<br/>47 Hz to 66 Hz<br/>Single band system: 595 WATTS MAX<br/>Dual band system: 726 WATTS MAX</i> |
| <i>Weight</i>                    | <i>Single band system: 249 kg (548 lbs)<br/>Dual band system: 269 kg (592 lbs)</i>   |
| <i>Dimensions (H x W x D)</i>    | <i>112 x 59.9 x 143.5 cm (without monitor)<br/>44.1 x 23.4 x 56.5 in (without monitor)</i>   |

---

## Regulatory Information

- This product is classified as Class I according to 21 CFR 1040.10 and Class I according to IEC 60825-1.
- This product complies with 21 CFR 1040.10 and 21 CFR 1040.11.
- This is to declare that this system is in conformance with the German Regulation on Noise Declaration for Machines (Laermangabe nach der Maschinenlaermverordnung -3.GSGV Deutschland).

### **Notice for Germany: Noise Declaration**

| Acoustic Noise Emission | Geräuschemission    |
|-------------------------|---------------------|
| LpA < 70 dB             | LpA < 70 dB         |
| Operator position       | am Arbeitsplatz     |
| Normal position         | normaler Betrieb    |
| per ISO 7779            | nach DIN 45635 t.19 |

**Regulatory Information**

---

## Declaration of Conformity

| <b>DECLARATION OF CONFORMITY</b><br><small>According to ISO/IEC Guide 22 and EN 45014</small>  |  |
|--|--|
| <b>Manufacturer's Name:</b>  | Hewlett-Packard Co.  |
| <b>Manufacturer's Address:</b>   | 1400 Fountaingrove Parkway<br>Santa Rosa, CA 95403-1799<br>USA |
| Declares that the product:   |  |
| <b>Product Name:</b>   | Chromatic Dispersion Test System                               |
| <b>Model Number:</b>   | HP 83427A, HP 86037A, 86037B                                   |
| <b>Product Options:</b>  | This declaration covers all options of the above product.      |
| Conforms to the following product specifications:  |  |
| Safety: IEC 61010-1:1990 / EN 61010-1:1993<br>CAN/CSA-C22.2 No. 1010.1-92  |  |
| EMC: CISPR 11:1990/EN 55011:1991 Group 1, Class A<br>IEC 801-2:1984/EN 50082-1:1992 4 kV CD, 8 kV AD<br>IEC 801-3:1984/EN 50082-1:1992 3 V/m, 27-500 MHz<br>IEC 801-4:1988/EN 50082-1:1992 0.5 kV sig. lines, 1 kV power lines |  |
| <b>Supplementary Information:</b>  |  |
| The product herewith complies with the requirements of the Low Voltage Directive 73/23/EEC and the EMC Directive 89/336/EEC and carries the CE-marking accordingly.  |  |
|    |  |
| Santa Rosa, CA, USA June 10, 1999  | Greg Pfeiffer/Quality Engineering Manager                      |
| <small>European Contact: Your local Hewlett-Packard Sales and Service Office or Hewlett-Packard GmbH Department HO-TRE, Herrneberger Strasse 130, D71034 Boblingen, Germany (FAX +49-7031-14-3143)</small>                     |  |

---

# Index

## Symbols

#steps, 2-6

## Numerics

1300 nm, 2-22

1500 nm, 2-22

3 term Sellmeier, 2-28

3 term sellmeier curve fit, 2-30

5 term Sellmeier, 2-28

5 term sellmeier curve fit, 2-30

## A

Absolute Group Delay Measurement area, 2-14

Addresses command, 2-19

Agilent 86037A

options, 7-17

Agilent offices, 5-35

Agilent Support, 5-18

on-site system repair, 5-18

archiving data, 2-33

ASCII files, 2-29

Average Factor, 2-16, 2-17, 3-14

## B

block diagram

option 112, 7-4

option 113, 7-5

standard system, 7-3

Bragg gratings, 2-14, 7-9

## C

cabinet, cleaning, iv

Cable, 2-8

cable label, 2-8

care

of cabinet, iv

care of fiber optics, 1-5

CD and Gain measurement, 2-16

CD Graphs tab, 2-25

CD List

tab, 2-25

CD List tab, 2-25

CD measurement only, 2-16

CD statistics viewing, 2-27

CD/Gain Meas command, 2-15

cds filename extension, 2-15

characteristics

multi-wavelength meter, 8-5

tunable laser source, 8-5

chirp, 7-9

chromatic dispersion

compensators, 7-9

material dispersion, 7-8

modulation phase shift, 7-2

polarization-mode dispersion, 7-8

propagation delay, 7-8

pulse modulation, 7-8

specifications, 8-3

waveguide dispersion, 7-8

What is..., 7-8

classification

product, iv

cleaning

adapters, 5-29

cabinet, iv

fiber-optic connections, 5-20, 5-28

non-lensed connectors, 5-28

clipboard, 2-29, 2-31

column headings, 2-30

Combined command, 2-18

Compact Database command, 2-34

components Agilent 83427A, 7-6

compressed dust remover, 5-27

connections

polarization-maintaining fiber, 6-10

connector

care, 5-20

cotton swabs, 5-27

Create Database command, 2-32

curve fitting, 2-28

Custom, 2-10

## D

Data Presentation command, 2-31

data review, 2-3

database, 2-32

Database Options command, 2-20, 2-32

Delta, 2-6

diode laser, 7-8

dispersion, 2-25

at 5 preferred wavelengths, 2-30

## Index

- curve, 2-25
- direct calculated, 2-30
- fitted, 2-30
- shifted fiber, 2-28
- slope, 1-10

displayed values, 2-17  
dust caps, 5-28

## E

EDFA. *See* erbium-doped fiber amplifiers  
Edit menu, 2-31  
Edit names, 2-8  
electrostatic discharge, 5-30  
environmental temperature, 2-35  
erbium-doped fiber amplifiers, 7-9  
ESD

- reducing damage caused by ESD, 5-31
- static-safe work station, 5-31

Exit, 1-9  
Export Data command, 2-29  
export file format, 2-30

- 3 term sellmeier curve fit, 2-30
- 5 term sellmeier curve fit, 2-30
- column headings, 2-30
- dispersion, 2-30
- dispersion at 5 preferred wavelengths, 2-30
- gain, 2-30
- gain peak and FWHM, 2-30
- group delay, 2-30
- quadratic fit coefficients, 2-30
- statistics for groups, 2-30
- test date and time, 2-30
- test information and conditions, 2-30
- TLS power, 2-30

exporting data, 2-30

## F

Faster, 2-10  
Fastest, 2-10  
Fiber, 2-8  
fiber

- Bragg gratings, 2-14, 7-9
- length, 1-10
- singlemode, 7-8, 7-9

Fiber label, 2-8  
Fiber Optic Test and Measurement, book, 1-2

fiber optics

- care of, 1-5
- cleaning connections, 5-20
- connectors, covering, 5-33

Fiber Related Parameters area, 2-4, 2-12  
fiber related parameters area, 2-12  
File menu, 2-15, 2-29  
filename extension, cds, 2-15  
foam swabs, 5-27  
frequency modulation, 1-10  
fuse

- values, iv

## G

gain, 2-30  
gain graph tab, 2-26  
gain measurements, 2-23  
gain peak and FWHM, 2-30  
GPIB

- addresses, 2-19, 5-8
- interface, 5-8

graph pane, 1-9  
Grating Related Parameters area, 2-4, 2-14  
gratings, 2-14, 7-9  
group delay, 1-10, 2-14, 2-25

- fitted, 2-30
- measured, 2-30

## H

HP Defaults, 2-15, 2-17

## I

identification labels, 2-20  
IEC Publication 61010-1, iv  
input

- connector, 5-20

insertion loss, 2-5  
instrument

- returning for service, 5-32

## K

km, 2-23, 2-25



**L**

labels, 2-8, 2-20  
 laser diode, 7-8  
 laser source  
   characteristics, 8-5  
   power level, 2-16, 2-30, 3-14  
   target power, 2-17  
   wavelength, 2-17  
   wavelength feedback mode, 2-14  
 Length area, 2-12  
 length measurement  
   specifications, 8-5  
 Length Measurement command, 2-17  
 Length not required, 2-12  
 line-power  
   cables, 7-16  
   specifications, 8-6  
 list pane, 1-9

**M**

main window, 2-3  
 material dispersion, 7-8  
 Max Cal Device Length, 3-14  
 mean value comparison, 7-12  
 Measure, 2-12  
 Measurement  
   Speed Parameters area, 2-4  
 measurement  
   exporting results, 2-29  
   gain, 2-23  
   optimizing accuracy, 1-10  
   speed, 2-10  
   time, 2-16, 2-17  
 Measurement Speed Parameters area, 2-10  
 Measurement Wavelength, 2-14  
 measurement, time, 2-7  
 menu bar, 2-4  
 modulation  
   frequency, 1-10, 2-15  
   phase shift, 7-2  
 Modulation Frequency, 3-14  
 Modulator Bias button, 2-5, 3-7, 3-10  
 modulator, biasing, 2-5  
 Move Data to Archive command, 2-33  
 multi-wavelength meter, 2-14  
   characteristics, 8-5

**N**

network analyzer description, 7-3  
 New Normalization button, 1-8, 2-5, 3-4  
 noise, 2-25  
   declaration, 8-7  
   reduction, 2-16, 2-17, 3-14  
 Normal, 2-10  
 normalization  
   copying wavelengths, 2-17  
 Normalization area, 2-4  
 normalization area, 2-9  
 Normalization command, 2-18, 3-13  
 Notepad button, 2-5  
 multi-wavelength meter  
   adding, 2-20  
 number of measurements, 2-18  
 Number of Tries, 2-14

**O**

Open Database command, 2-32  
 Open Setup command, 2-15  
 Operator, 2-8  
 optical amplifiers, measuring keen, 2-16  
 optical-to-electrical converter, 7-3  
 Option 112 Block Diagram, 7-4  
 Option 113 Block Diagram, 7-5  
 options, 7-17

**P**

packaging for shipment, 5-33  
 patch cords, 1-8, 3-6  
 Pause between wavelength ranges command,  
   2-22  
 performance repeatability, 7-13  
 periodic normalization, 3-4  
 PMD. *See* polarization-mode dispersion.  
 polarization-maintaining fiber  
   connections, 6-10  
 polarization-mode dispersion, 7-8  
 power, 7-7  
   level, 2-16  
   requirements, 7-7  
 power monitor, 1-8  
 Power Monitor button, 1-8, 2-5  
 Power Monitor Settings command, 2-22  
 power switch, 1-9

## Index

preferences  
  command, 2-20  
  menu, 2-31  
Preferences menu, 2-31  
preferred wavelengths, 2-31  
Print command, 2-29  
propagation delay, 7-8  
pulse modulation, 7-8

## Q

quadratic curve fit, 2-28, 2-30

## R

rack power requirements, 7-7  
Range menu, 2-18  
recall, 2-31  
receiver input, 1-8, 2-35, 3-6, 3-7, 3-8, 3-10  
Ref, 2-7  
reference wavelength, 2-7  
regulatory information, 8-2  
reinstalling the software, 5-16  
Remarks, 2-8  
remarks, 2-8  
Repair Database command, 2-32  
Repeat Cycles area, 2-12  
repeatability  
  performance, 7-13  
  results, 7-11  
returning for service, 5-32  
Review Data button, 2-5  
review data window, 2-23

## S

safety, iv  
  laser classification, iv  
sales and service offices, 5-35  
Save Setup As command, 2-15  
Segment, 2-8  
segment label, 2-8  
Select TLS command, 2-22  
Sensitivity, 3-14  
sensitivity, 2-16, 2-17, 3-14  
service, 5-32  
  menu, 2-22  
  returning for, 5-32

  sales and service offices, 5-35  
Service menu, 2-22, 3-8  
Set length to, 2-12  
SetParametersFor menu, 2-15  
shipping  
  procedure, 5-32  
singlemode fiber, 7-8, 7-9  
software  
  installation, 5-16  
source output, 1-8, 2-35, 3-6, 3-7, 3-8, 3-10  
SOURCE OUTPUT connector, 1-4  
specifications, 8-2  
  chromatic dispersion measurement, 8-3  
  length measurement, 8-5  
  operating, 8-6  
spreadsheet file, 2-29  
standard system block diagram, 7-3  
Start, 2-6  
start test, 1-8  
Start Test button, 2-5  
statistics for groups, 2-30  
Stop, 2-6  
swabs, 5-27  
system  
  length measurement specifications, 8-5  
  turning off, 1-9  
System menu, 2-19  
system menu, 2-19

## T

tabs, 2-23  
taskbar, 1-9  
Temperature, 2-8  
temperature label, 2-8  
test  
  date and time, 2-30  
  fiber stability, 2-35  
  identification area, 2-4, 2-8  
  information and conditions, 2-30  
test and tool buttons, 2-4  
Test Manager, 2-8  
test manager label, 2-8  
test set  
  receiver input, 1-8, 2-35, 3-6  
  source output, 1-8, 2-35, 3-6  
TLS Target Power, 3-14  
troubleshooting, 5-4

- tunable laser source
  - power level, 2-16
- tuning accuracy, 2-14
- turning off power, 1-9

## V

- Verify cal limit, 3-14
- verify normalization, 1-8
- Verify Normalization button, 2-5, 3-6
- viewing CD graphs, 2-25, 2-27

## W

- waveguide dispersion, 7-8
- wavelength, 1-10
  - #steps, 2-6
  - Delta, 2-6
  - division multiplexing, 7-9, 7-10
  - meter, 2-20
  - preferred, 2-31
  - range, 2-6
  - reference, 2-7
  - settings, 2-6
  - start, 2-6
  - stop, 2-6
- Wavelength Meter command, 2-20
- Wavelength Selection area, 2-4
- WDM. *See* wavelength division multiplexing

## Y

- y-axis data, 2-23

## Z

- zero dispersion wavelength, 1-10

